

Special-Sensors for Automation



Flow Sensors

Contents

Technique and application for flow sensors

Technique and application for flow sensors, amplifiers and compact models	1.03 - 1.07
Terminology / Setting instructions	1.08 - 1.09
Technique and application for flow sensors inline-digital display	1.10
Ex area certification	1.11
Technique and application IO-Link, sensors with IO-Link	1.12 - 1.17

Flow sensors Series 400 / Series 500

Probes Series ST / STK	1.20 - 1.23
Probes high temperature 120 °C Series ST	1.24 - 1.25
Probes chemical resistant Series STA	1.26
Compact models Series SC 440 / SCS 440	1.27 - 1.28
Compact models Series SNS 450 / SN 450	1.29 - 1.33
Compact models with analog output Series SNS 450 / SN 450	1.34 - 1.35
Compact models with two switching points Series SN 450	1.36
Compact models with temperature controll Series SNT 450	1.37 - 1.39
Compact models with turn on/off delay Series SN 450	1.40
Inline-Sensor Series SD	1.41
Inline-Compact Series SDN / SDNC / SDNC with IO-Link	1.42 - 1.49
Special-Probe Food / Pharma Series SCB / STB / STC	1.50
Inline-Compact Series SDB / SDN	1.51 - 1.52

Flow sensors Inline-Flow monitoring Serie SDN / SDV / SDI

Inline-Compact with digital display Series SDN 552 / SDN 554	1.53 - 1.57
Vortex-Measuring device with digital display Series SDV 652	1.58
Magnetic flowmeter with digital display Series SDI 852 / SDI 853	1.59 - 1.60

Air flow sensors Series 400 / Series 500 / Series 1000

Probes Series LTZ 421	1.61
Compact models Series LN / LG	1.62
Compact models screw-on mounting Series LNZ 450	1.63 - 1.64
Compact models sleeve mounting Series LN 450	1.65 - 1.66
Inline-Compact air flow Series LDN	1.67
Air flow sensors with IO-Link Series LDN / LDV / LDS	1.68 - 1.70

Amplifiers for sensors

Amplifiers Series SKM / SKZ	1.71 - 1.75
-----------------------------------	-------------

Flow sensors, air flow sensors and amplifiers for Ex-applications

Ex-Probes Series STS / ST – Category 1 / Category 2	1.78 - 1.85
Ex-Probes Series STS / ST – Category 1 / Category 2 with flange	1.86 - 1.88
Ex-Probes Series STSEX – Category 1 with terminal clamps	1.89
Air flow Ex-Probes Series STS – Category 1 / Category 2	1.90 - 1.92
Air flow sensors Compact models Series LNZ – Category 3	1.93
Amplifiers Series SZA	1.94
Ex junction box Series GK – Category 2	1.95 - 1.97

Accessories

IO-Link Master	1.98
M12 connector	1.99 - 1.100
Cable	1.101
Assembly parts	1.102 - 1.103

Technical alterations are reserved to us without prior announcement.

Technique and application

Function

The function of the flow controller is based on the thermodynamic principle. The sensor is heated internally a few degrees °C compared to the medium into which it projects. When the medium flows, the heat generated in the sensor is conducted away by the medium, i. e. the sensor cools down. The temperature within the sensor is measured and compared to the temperature of the medium. The state of flow can be derived for each medium by the temperature difference attained.

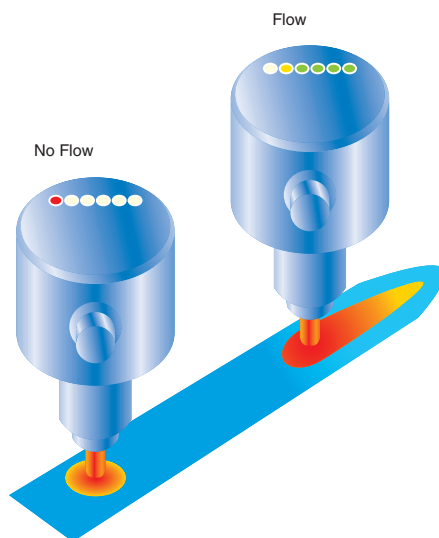

Function of thermodynamic flow controllers

On the basis of this functional principle EGE manufactures flow monitors for liquid and gaseous media.

The sensitivity of thermodynamic flow monitors depends on the thermal characteristics of a medium. The detection range of a standard sensor for oil, for example, is three times as great than for water and for air is approx. 30 times greater than for water due to the reduced heat conductivity. Unless stated otherwise, the technical sensor data are specified for water.

Areas of application for flow monitors

Thermodynamic flow monitors function without any moving parts, therefore they are not subject to failure due to corroded bearings, torn impellers or deflector deformation. This reliability is highly valued in many industries. Today, flow monitors are used both in liquids and in air, and are employed even in explosion hazardous environments.

Monitoring of cooling

- The cooling water on welding machinery is monitored using compact stainless steel devices. This ensures sufficient cooling even for rapid cycles, otherwise the welding robot will be switched off by the sensor.
- The cooling lubricant flow is monitored continuously in processing centres. The tools are protected and have a greater service life.

- In metal processing, e.g. rolling mills and wire drawing machines, the rolls and coils will be cooled continually. This is monitored by thermodynamic sensors. Due to the rough environmental conditions the sensors are designed for up to 160 °C and settings are made away from the heat with special amplifiers.

Monitoring of flow medium

- The run-dry protection of pumps is a frequent application, which often uses compact sensors with time delay.
- In dosing technology the aggregate, usually small flow quantities, is measured exactly by means of inline sensors. These sensors are inserted like a pipe into the line.
- Monitoring of filters and sieves can be ensured by medium flow control; if the flow is progressively reduced, the filter must be renewed. Where this is not carried out, the pump is switched off in a second stage should the medium flow drop further. This uses a sensor with two switching points.

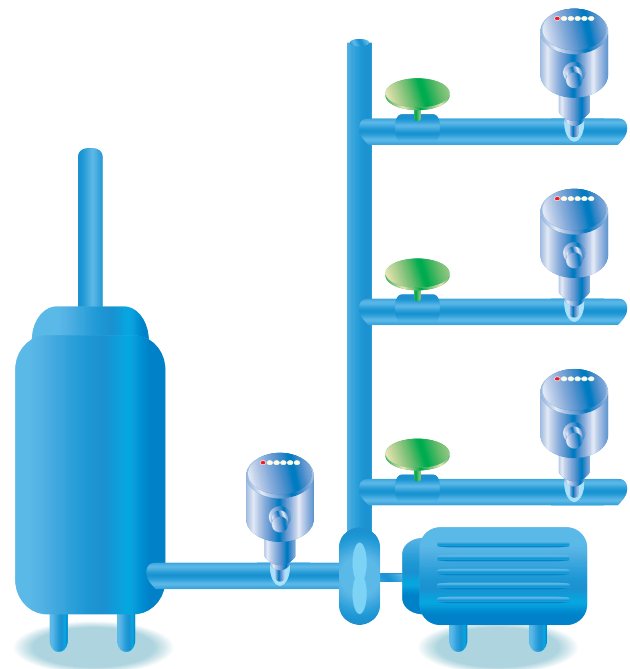

Run-dry protection of a feed pump

Monitoring of process flow

- The monitoring of cleaning processes using aggressive media at times is often only possible with special materials, e.g. hastelloy or tantalum.
- Extraction systems for hazardous vapours at laboratory workstations as well as the hall ventilation in the hexane processing industry are monitored using airflow sensors.
- CIP/SIP processes can be monitored and documented with flow monitors.

Technique and application

Probes

The temperature-sensitive measuring elements are fitted in the tip of the probe. The probe tip and the adjoining thread/mounting part are made in one piece of stainless steel in many probes. This guarantees absolute tightness and high compressive strength. Special materials are used in corrosive, and particularly in oxidizing media, since stainless steel shows only limited resistance to corrosion in this application.

In standard applications, probes can be mounted independently of the direction of flow of the medium. In any case, it is important to make sure that the pin of probe is completely surrounded by the medium to be monitored. Please note that for smaller cross-sections the sensor tip narrows the tube's cross-section. This results in a higher flow rate.

In order to avoid malfunctions caused by unstable flow patterns no fittings that could affect the flow cross-section or the flow direction should be placed directly in front of and behind the sensor. The point of reference for the input/outlet section is approximately 5 to 10 times the tube diameter.

Assembly

Probes with short thread-pieces of the STK... type are particularly suited for fitting into T-pieces. Sensor length is designed in such a way that the probe tip is completely immersed in the medium without touching the opposite side.

Probes with long thread-pieces of the ST... type are suitable for larger pipe diameters or for use with longer assembly thread-pieces. Probes threads are G-pipe threads to DIN ISO 228 and also comply with the BSP standard. A flat gasket centered by a step on the sensor ensures a good seal. A good seal can also be ensured using Teflon tape. For pressure above 30 bar or very high screw-down torques, a flat gasket may be damaged, especially if it is made of plastic. In this case, a recess must be incorporated into the fitting which will keep the gasket in the right position in the case of high loads. PTFE gaskets must always be used with this technique. For high pressure applications, metal gaskets must be used. The standard material for gaskets is AFM 30/34. Special gaskets made of other materials such as moving iron, copper or PTFE are also available on request.

Dimensions of the gasket

Thread	d	D	h	t
G1/4	13.2	19.5	1.5	1
G1/2	21	27.5	2	1.5
G3/4	26.5	32.5	2	1.5

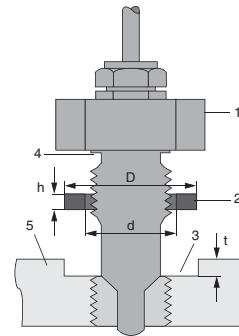

- 1 = Probe
- 2 = Gasket
- 3 = Chamber
- 4 = Edge
- 5 = Counterpart

A rising pipe should be used in case of open systems or in the presence of air pockets (1). Deposits and air pockets do not impair sensor function in the case of lateral assembly (2), providing the sensor is completely immersed in the medium. Assembly from below (3) assures flow monitoring function even if there are air pockets in the pipe. However, the monitored medium level must not fall below the upper edge of the measuring tip. Assembly from above is only applicable if there is no air in the pipe.

① Installation in rising pipe

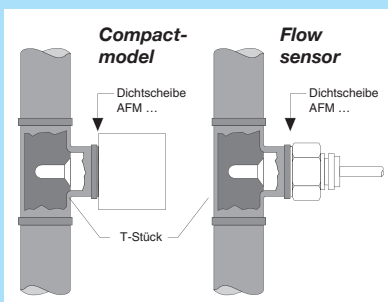

② Lateral installation

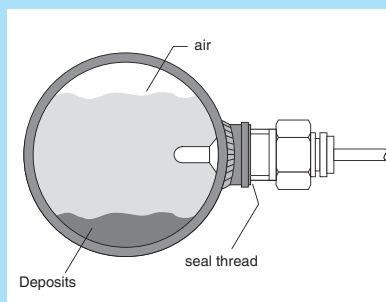

③ Underside installation

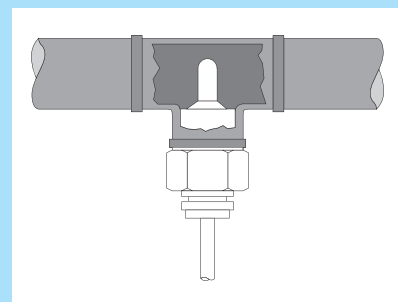

Technique and application

NPT threads

NPT threads can be provided as an alternative for all types which have a G1/2 or a G3/4 thread. NPT threads are conical and must be screwed into an equally conical counter-part. Two types of NPT threads must be distinguished. NPT thread according to ANSI B 1.20.1 does not ensure a good seal by itself and requires the use of a sealing medium, e.g. Teflon tape. It is not possible to use flat gaskets with this type of thread.

Flange types

Standardised pipe connections are required particularly in the chemical, pharmaceutical and foodstuff industries. Sensors for use in these areas are supplied with flange connections per DIN or ASME. Sensor and flange form a corrosion-proof connection using laser or inert gas shielded arc welding.

Food-approved screw connections

For hygienic reasons the food and pharmaceutical industries place special demands on the mechanical and electronic characteristics of sensors.

Probes with food-approved connections, e. g. Triclamp or dairy pipe connections (DIN 11851) comply with the 3-A sanitary standard 28-05. Due to the temperature changes involved, the usual cleaning cycles CIP and SIP place a particular demand on sensor electronics. Therefore, special protective measures are taken. Sensor materials for these applications is mainly the special steel AISI 316 L. Customer-specific connections, e. g. GEA-Varivent or APV flanges are available, as are other special metallic materials.

Extra long probes

Flow probes are available in screw lengths of 25 mm to 300 mm. The probe length should be selected such that the measuring tip is within an area of stable flow characteristics.

Main applications are:

- detection of small flow velocities in pipes with large cross section
- mounting of the sensor with a standard flange
- use of extra long welding sleeves if the piping is surrounded by a supplementary insulation.

Inline

Inline sensors are inserted directly into the line of a pipe. This design does not feature any measuring pins protruding into the flow. EGE inline sensors SD of series 500 are suitable for flow volumes from 0.5 ml/min to 6 l/min. These sensors excel through smooth measuring pipes, low pressure loss and fast response to flow changes. A multitude of connection options are available.

Chemical stability of probe housings

The chemical stability of the materials used must be verified individually for every application. Basically, no problems occur if the probe and the piping are made of the same material. It is always advantageous if the sensor housing is made of a more noble material than the piping.

The screwed cable gland on the rear side of the ST... sensors is designed in nickelplated brass. Order material PVDF for screwed cable glands in applications that are cleaned with alkaline cleaning agents as is the case, for example, in the food industry.

Stainless Steel belongs to the group of chromium-nickel alloys containing further components such as molybdenum or titanium. The proportions of the different alloy components is critical to the resistance to corrosion in the medium. For this reason, there exists a large number of materials identified by numbers to the DIN EN ISO 7153-1:2000 standard. Due to its good corrosive resistance in many areas of application, AISI-316 Ti (VA4) stainless steel is a frequently used material. It may be used in installations used to obtain water, in air conditioning systems, in food processing industries such as dairy products, meat products, beverages, wine production or in kitchen installations. Stainless steels have a restricted stability in chlorinated or poorly oxygenated atmospheres. Special alloys must be used for such applications.

Long sensor

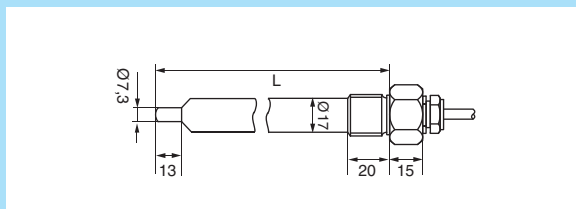

Immersion depth "L" is determined by the distance between the sealing face and the sensor tip. Standard lengths which can be supplied are: L = 80 and 120 mm; in the Ex-area 80, 110 and 140 mm.

Technique and application

Special materials

Hastelloy B-2 (2.4617) belongs to the group of highly corrosion-resistant nickel-molybdenum alloys.

This material has excellent characteristics in reducing media, e.g. in hydrochloric acid of any concentration and for a large range of temperatures. It can also be used in hydrochloric, sulphuric, acetic and phosphoric acid media. Good resistance against corrosion such as pitting, crevice corrosion, chlorine induced stress, corrosion cracking, hair-line corrosion, abrasion and corrosion within the heat influence zone allows for a large range of applications. In the presence of oxidising components such as iron or copper salts, the use of this material is not recommended.

Hastelloy C-22 (2.4602) belongs to the group of high corrosion-resistance nickel-chromium-molybdenum-tungsten alloys. The material is characterised through high resistance against crevice corrosion, pitting and stress corrosion cracking in oxidising and reducing media. It also displays good behavior in the presence of a large number of corrosive media, including strong oxidants such as iron (III) chloride and copper (II) chloride, hot media, e.g. sulphuric acid, nitric acid, phosphoric acid, chlorine (dry), formic acid and acetic acid. Furthermore, it has satisfactory characteristics in humid chlorine gas, as well as in sodium hypochlorite and chlorine dioxide solutions.

Titanium (3.7035) is a light metal with mechanical strength values equivalent to those of high quality steel. The good chemical resistance of this metal is due to the fact that an oxide film is formed on its surface, as is also the case with stainless steels. If this protective layer undergoes mechanical damages in an oxygenated environment, it is immediately renewed (titanium will resist even aqua regia). Titanium is not stable in environments containing no oxygen or in reducing environments. It is particularly suitable for applications in chloride-containing media. Experience in the chemical industry and in paper bleaching factories has shown that titanium is the only material allowing undisturbed production. The excellent characteristics of titanium also give optimum results in sea water cooling systems and sea water de-salinising plants.

The material is particularly suited for the application of coating with other metals and metal ceramics. These supplementary coatings noticeably increase its chemical stability and thus the lifetime of sensor housings.

High temperature

High temperature sensors are manufactured from temperature-resistant components and feature FEP cables.

The functional range of these special probes of series 400 is specified as +10...+120 °C. Temporarily 135 °C is permissible for max. 10 min. High temperature sensors of series 500 can be used for media temperatures of up to 160 °C / 320 °F

Connection

Flow monitoring probes are available with a M12 plug connector or fixed cable. Special models have a terminal compartment.

The connection cable from the probe to the amplifier may be up to 100 m long. For distances above 30 m a shielded cable is preferred. In all cases the chosen wire strength must be checked against the requirements.

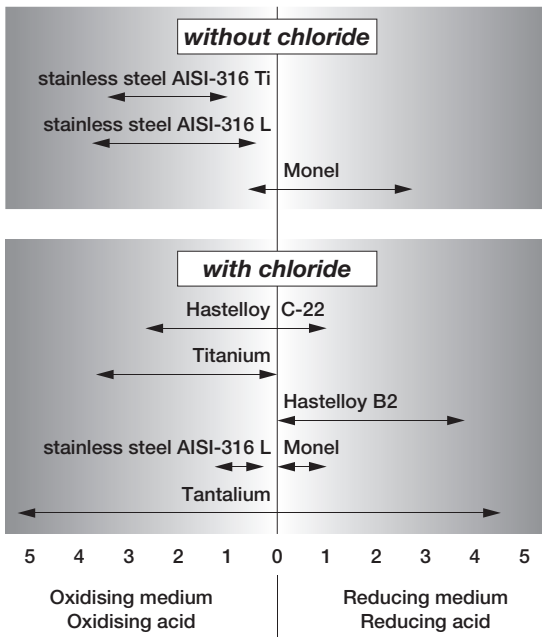

Chemical resistance of B3-coating

Medium	Cl ₂	HCl	Br ₂	HBr	F ₂	HF	HA (general)	NaOH	Saltw. (Kestern)	red. media	HNO ₃	H ₂ SO ₄ (25%)
resistance	+++	+++	+++	+++	+	+	+++	++	+++	++	++	+++

HA in generell = Acid. acid in different concentrations
 Saltw. Kestern Resistance = Saltw.-Kesternich-Test = proofed up to 30 °C

Coating properties

The coating is hard, resistant to wear and resistant to abrasive substances in media like for example chalk, mud, sand and fiber.

Technique and application

Amplifiers

All amplifiers have a multicolour LED display which visually indicates the flow tendency. If the LED light is red, the preinstalled limit value is not reached and the switching output is not activated. The yellow LED indicates that the limit value was reached and the output is active. In addition to the yellow LED, 4 more green LEDs can light up to indicate how much the limit value is exceeded.

For the installation of the amplifiers, make sure that the devices are not subject to heat build-up. The distance between adjacent devices should not be less than 10 mm.

Amplifiers SKZ... and SKM...

Terminal rail devices SKZ... and SKM... are prepared for installation on the top hat rail. They evaluate the signals delivered by the measurement probes and provide relays or analog outputs. The settings are made using two potentiometers that are accessible from the front or via buttons for SKM 522. In addition, SKZ amplifiers provide a switch-off delay as well as temperature monitoring.

EX amplifier SZA...

For EX measurement probes, the SZA... amplifiers with an adjustable turn off delay are offered. It has an own intrinsically safe circuit to which the measurement probes are connected. This safe circuit is galvanically isolated from the mains and isolated from the relay output.

The EX amplifier SZA... must be set up outside of the hazardous area..

Compact devices

Compact devices integrate amplifier and probe within one housing. This permits setting a limit value directly at the measuring location. The cabling is thus reduced to the less interference-prone mains supply cables and the switching output.

Screw assembly

SC 440... / SN 450... / LN 450... / LNZ 450...

Compact devices of the series mentioned can be easily assembled in screw adapters, bushings and T-pieces. To this end the measuring probes usually have a thread of size G1/4, G1/2 or NPT1/2. Many other options can be implemented as special device.

The devices of series SC 440... are completely manufactured from stainless steel and characterised by robustness and a small footprint. They have been proven in more than 25 years of industrial use. Series SN 450... and SNT 450... have a plastic (PBT) housing and are available in many designs for direct and alternating voltage supply, with relay, PNP or analogue output. The STN 450... variants additionally feature an adjustable temperature monitoring, the variants with ...-VA or ...-VE have an adjustable time delay for the output. The compact devices LN 450... and LNZ 450... are suitable for use in air. They are available in the same variants as SN 450...

SCS 440... / SNS 450... plug-in assembly

The measuring probes of the above-mentioned device series have been designed for assembly in cutting ring fittings. They are secured in the respective fitting with a union nut attached to the device. The connection is reliably sealed up to 100 bar. Various designs of the screw-in adapter allow the universal use of the flow sensor. The variants of the compact devices match the variants available for screw assembly.

"Inline" assembly

SDN 500... / SDN 552... / SDNC 500...

"Inline" assembly is through two opposing process connections at the device directly in a pipe or hose. The measuring tubes of the inline sensors are smooth on the inside and do not feature any pins protruding into the flow. They are characterised by short response times and a large detection range. Due to their compact design they can also be used where installation space is tight. For pulsating flows the inline sensors SDN... -DYN are suitable, which can detect very brief flow rates of the smallest volumes as soon as the flow starts. The SDN 500... are equipped with PNP, relay or analogue outputs.

Sensors of the series SDNC... have a space-saving cubic design and opposing process connections with a G1/4 thread. They have a wide detection range and are sometimes operated with a screw-on pre-adapter or a straight inlet section providing a favourable flow profile for the flow rate detection. This device series has been preconfigured at factory or can be supplied flexibly parametrisable using an IO link. This design also offers a pulse output for simple volume detection.

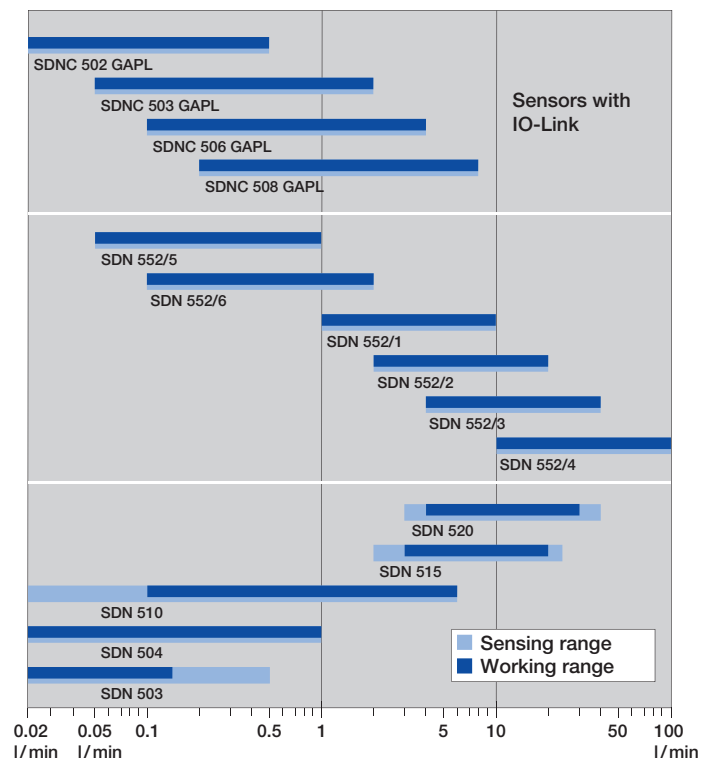

Flow ranges for EGE-Inline-Compact models

Technique and application • Terminology

Detection range

The detection range of a probe or compact device indicates the flow velocities of the medium for which the probe can provide an analysable signal. If the medium is not specified, the details for water are applied. Because the different media have different thermal conductivity, the detection range as well as the temperature drift are also dependent of the respective medium. At the upper and lower limit of the detection range, the temperature drift is higher. The detection range does not limit the maximum flow rate a sensor may be exposed to. Hence, a sensor with the upper detection limit set at 3 m/s can be operated at 10 m/s.

Operating range

The operating range characterises the section of the detection range for which the flow technology data have been specified. At the outer limits of the detection range these data are reduced. For sensors preconfigured at factory the working range represents the display or output range.

Nominal flow

For each sensor, data corresponding to its own nominal flow is measured. This is necessary because response characteristic curves of sensors are non-linear. Consequently the various sensor characteristics depend on the location of the chosen operating point on the curve. As a rule, the nominal flow-point is set in the middle of the portion of the (simple logarithmic representation of the characteristic) curve which appears to be linear. For this operating point, the following values may be defined: switching on and off times, stand by time, hysteresis and temperature response.

Supply voltage

The supply voltage is the voltage range within EGE Sensors function safely. For direct current supplies it must be ensured that the limits are maintained even including residual ripple.

Current consumption

The current consumption is the maximum value of the idle current I_0 which the flow monitor draws without load.

Switching current

The switching current indicates the maximum continuous current for the switching output of the device. For PNP outputs this value applies to an ambient temperature of 25 °C. At higher temperatures the maximum switching current is reduced. For devices with relays output the value is related to the utility category AC-12 or DC-12 in accordance with EN 60947-5-1.

Switching voltage

The switching voltage indicates the maximum voltage (including residual ripple) to be switched with the relay output.

Switching power

The switching power indicates the maximum power to be placed on the output relays.

Ambient temperature

The ambient temperature indicates the maximum and minimum permissible temperatures for the sensor.

Temperature of medium

The temperature range for which a sensor is rated. Applies to the medium to be monitored.

Temperature gradient

The temperature gradient defines the maximum temperature change of a medium per time unit which a sensor can track without malfunction. It is a measure for the quality of a flow sensor. The temperature gradient is determined at nominal data and with symmetrical installation of the measuring probe.

Start-up time

The start-up time is the period of time required by the flow detector to reach a stable state after the operating voltage has been switched on. Prerequisite is that the medium flows at the rated velocity and that the sensor has adapted to the temperature of the medium before switching the supply voltage on. The start-up time is prolonged in a static medium and reduced if the medium flows faster than the rated value.

Reaction time

The reaction time combines the switch-on and -off time. Switch-on time elapses from the beginning of the flow until the switching point set at the amplifier is reached. Switch-off time characteristic results for the flow sensors at pump shut-down. If the set switching point is close to maximum flow, the time elapsing between the pump shut-down and the indication of the flow decrease is short. If the switching point is close to the static value, the off-transition time will be long.

Compressive strength

Pressure resistance relates to the sensor casing. Up to the indicated maximum pressure, the sensor provides a steady signal and the casing suffers no damage. In case the application requires the use of threaded joints, these can have compressive strengths that are significantly lower than the data for the sensor, which must then be observed.

Protection class

The protection class indicates how well the equipment is protected against ingress of solids and water in accordance with EN 60529. For probes, the stated protection class always refers to the connection area. The area which is in contact with the medium always has IP 68.

Switch-off delay

The variable time delay which can be set between 0 and 25 seconds becomes active during flow standstill (drop-out delay). If the medium ceases to flow and the amplifier display indicates this state, the relay contact is actuated only after the set delay. During the delay period the yellow LED lights up together with the red LED.

Cable break monitoring

Cable break monitoring shuts off the flow monitor output if no probe is connected or if the probe cable has been severed. In case of cable severing, "flow failure" signal is displayed. Cable break monitoring is available in the SKZ 400... The SKM 552... monitors each sensor cable for short circuit and cable break.

Switching output

General

- The output is active when the yellow LED is lit.
- Set the switching point with the potentiometer at the front of the device.
- Keep the flow rate and medium temperature stable during adjustment and wait for the temperature to equalise between the sensor and the medium.
- The flow rate must be within the detection rate of the measuring probe.
- If present, remove the protective screw M3 x 4 from the potentiometer opening for the duration of configuration.

Monitoring a flow limit for being exceeded

- Specify the flow rate or stop the flow and wait for the standby time.
- Turn the potentiometer screw clockwise until the yellow LED is lit.
- Turn the potentiometer screw counter-clockwise until the red LED is lit. The relay contacts are open.
- Increase the flow rate. Monitor the LED displays and switching output. If the limit value is exceeded, the yellow LED is lit and the relay contacts close. For a reliable monitoring the first green LED should also be lit after the flow commences. If necessary, change the adjustment.

This calibration is only possible if the flow rate of the medium is max. 70% of the limit value of the detection range of the selected measuring probe. If the red LED does not go out, the selected flow rate is too high or the hysteresis of the analysis device too great.

Monitoring a flow limit for being fallen below or standstill

- Specify the flow rate and wait for the standby time.
- Turn the potentiometer screw counter-clockwise until the red LED is lit.
- Turn the potentiometer screw clockwise until the yellow and 2 green LEDs are lit. The relay contacts are closed.
- Reduce the flow rate and monitor the LED displays and the switching output. If the yellow LED goes out, the relay contacts open.

The switching point for the flow rate is adjusted using one or two potentiometers. For flow rates which are higher than the detection limit of the measuring probe the loss or reduction of the flow rate is reported when the speed falls within the detection range of the measuring probe.

Limit temperature calibration

The desired value can be set with a potentiometer. The output switches when the set value is exceeded. At the same time the corresponding red LED at the device is also lit.

Time delay calibration

The desired value can be set with a potentiometer. In the SKM 522 the configuration takes place in the programming mode. The values are shown on a scale. If the red LED already indicates a loss of flow, the output remains switched until the time has expired. Then the yellow LED also goes out.

Automatic adjustment for SKM 522

Simultaneously pressing the two front buttons will open the programming menu. The automatic adjustment is selected with the FUNCTION button and started with the SELECT button. The adjustment is completed a few seconds later when at least the yellow LED lights up. Flow rate and temperature must be kept constant before and during the adjustment process. The function MAN. ADJUST can subsequently be used to manually modify the switching point.

LED functions flow

- Red:**
 - Flow has been interrupted or the flow rate has fallen below the specified value. The "flow" relay has dropped out.
- Yellow:**
 - The set flow rate has been reached, the "flow" relay pulls in.
- Green:**
 - The set flow rate has been exceeded. There is extra flow capacity.

LED temperature function

- Red:**
 - The set temperature value is reached and the "temperature" relay has pulled in.

LED time delay function

- Yellow and Red:**
 - Flow is below the set value. "Flow" relay remains pulled in until the set switch-off delay runs out.

Analog output

Flow sensors with analog output supplies a current intensity which depends on the flow speed. The output current range is defined from 4 mA to 20 mA. The dependence between flow speed and output current is non-linear. The detection range is adjusted over two potentiometers: "Range" (▲) and "Adjust" (▲). The lowest value (>4 mA, 1st green LED) is set with the "Adjust" potentiometer at the smallest flow speed to be monitoring and the highest value (20 mA, 5th green LED) is set with the "Range" potentiometer at the highest flow speed to be monitored. The graph shows the characteristic lines obtained with the different settings.

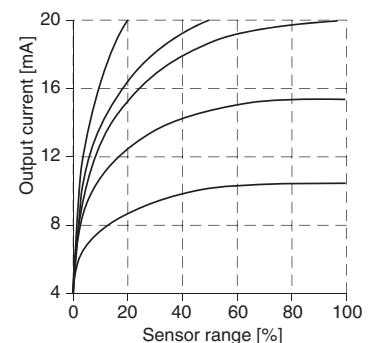
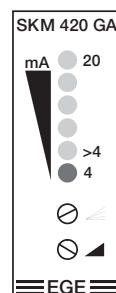

Flow monitoring and measuring

The EGE-inline flow controllers with digital display monitor flow rates in the range of 0,05...100 l/min and display the flow rate digitally. They feature front panel buttons used to call functions and modify settings. The application area includes all areas of flow monitoring and measuring, in which a flow display is desired.

Series SDN 552 / 554 – thermal principle

The SDN 552/554 series is based on the thermodynamic principle, heat is created in a measuring pipe and absorbed by the passing medium. The dissipated heat quantity is a measurement for the flow speed. A microprocessor processes this data, calculates the flow rate quantity and displays the result in liters/minutes in a 3-digit, 7-segment display.

Page 1.53 - 1.57

Series SDV 652 – vortex principle

The flow measurement devices Series SDV 652 are based on the vortex principle. They are well suitable for applications, where a good linearity and larger measurement precision is necessary. They are insensitive to quick temperature changes and the reaction time of the device is below one second.

The vortex principle allows a flow measurement without moving parts: Behind a bluff body in the flow, vortices are generated which are detected by the device and yield the flow velocity.

Page 1.58

Series SDI 852 / 853 – magnetic-inductive

The inline flow sensors SDI 852/853 offer a monitoring function as well as precise flow measurements in the range of 0...80 l/min with a measured error smaller than 2%. The flow rate is digitally depicted using a clear 3-digit, 7-segment display. The magnetic-inductive measuring system facilitates that this device is suitable for many different applications in the field of automating processes and workflows. Furthermore, a high degree of measuring accuracy is ensured.

The magnetic-inductive measuring principle requires the electrical conductivity of the medium. Low limit values of 15 $\mu\text{S}/\text{cm}$ for water or 10 $\mu\text{S}/\text{cm}$ for other fluids still offer a broad function range.

The combination of precise measuring system and small, compact design distinguishes the series SDI from other inline flow sensors. They are easy to install subsequently into existing configurations or offer a space-saving alternative for new constructions.

Cooling and temperature control as well as metering circuits, for example in the field of water treatment, are precisely and accurately monitored. This is accomplished with a set point function as well as an analogue linear current and pulse output.

Page 1.59 - 1.60

Installation

The inline flow sensors are installed "in-line" into a pipe line. The pipe may be connected directly with the compression tube fitting connection or with an adaptor SDA.... Threaded bushings are located in the bottom housing plate and are used to fasten the device to a support plate or other similar base. A mounting plate (optional accessory) may also be attached to the housing. This makes it possible to fasten the unit from the front.

Signal filter

The parameter for the signal filter allows inputting a value that determines the time interval in which the measuring signal is averaged. Inputs between 0 to 8 seconds are possible. A low value results in a very quick response; a high value results in a very steady display of the measured value. The filter is switched off when the setting is 0. Averaging has the same effect on display and outputs.

Access code

Protection against unauthorized access to the programming functions provides an access code. Without this number combination, only the currently saved values for the switching points and further parameters can be displayed.

Reference adjustment

The accuracy of the displayed flow rate quantity can be optimized with the CAL function using an exact reference flow rate meter. Here you have the option to modify the displayed flow rate value and adapt it to the reference value.

Medium preselection SDN 552 / 554

Besides water, a water-glycol mixture is also often used as a heat carrier in cooling systems. Due to the changed thermal properties of the fluid through the incorporation of glycol, the accuracy of the displayed flow rate value is affected and the limit values are also changed. To correct this effect, the devices of the SDN 552/554 type series have a function for selecting the measurement medium. Glycol fractions up to 30% can be entered. The microprocessor working in the device then calculates the flow rate quantities considering the glycol fraction.

Applications

These devices are especially suitable for flow rate monitoring in cooling systems due to the greater functionality, as well as easy programming and installation.

These devices are characterized by short response times and robust display values, even if the medium is subject to large temperature fluctuations as to be found in welding technology in the automotive industry.

In the display, the flow rate value, which is continuously updated, is displayed in l/min. The person responsible for the plant or the machine has thus constantly the information on the available cooling performance.

Industrial climate control units are often operated with a water-glycol mixture in the secondary cycle due to the danger of freezing. The glycol fraction can be programmed in the SDN menu in a couple of seconds to ensure a correct value is also displayed in the application.

Use in hazardous areas

The EX measurement probes of the 400 meet the basic requirements of Directive 94/9/EC. Electrical boundary data, permissible temperature ranges as well as installation and connection instructions are specified in the operating instructions of EX equipment.

Zone classification and categories

The frequency and duration of the occurrence of a hazardous atmosphere determines the zone classification.

Zone 0 / Category 1 (Gas)

Zone 0 is an area in which a potentially explosive atmosphere in the form of a mixture of air, combustible gases, vapours or fog continuously, for longer periods or frequently exists.

Zone 1 / Category 2 (Gas)

Zone 1 is an area in which a potentially explosive atmosphere as a mixture of air, combustible gases, vapours or fog can occasionally form in normal operation.

Zone 2 / Category 3 (Gas)

Zone 2 is an area in which a potentially explosive atmosphere as a mixture of air, combustible gases, vapours or fog can occur in normal operation.

Zone 20 / Category 1 (Dust)

Zone 20 is an area in which a potentially explosive atmosphere in the form of combustible particles suspended in air continuously, for longer periods or frequently exists.





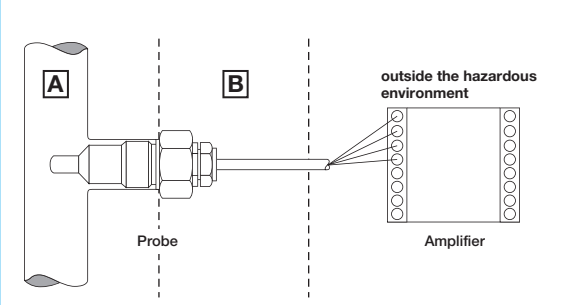

Zone 21 / Category 2 (Dust)

Zone 21 is an area in which a potentially explosive atmosphere in the form of combustible particles suspended in air can occasionally form in normal operation.

Zone 22 / Category 3 (Dust)

Zone 22 is an area in which a potentially explosive atmosphere in the form of combustible particles suspended in air normally does not exist or only exists for a short period in normal operation.



Ex marking	A	B
 II 1/2 G...	Zone 0	Zone 1
 II 2 G...	Zone 1	Zone 1
 II 3 G...	Zone 2	Zone 2
 II 1 D...	Zone 20	Zone 20
 II 2 D...	Zone 21	Zone 21
 II 3 D...	Zone 22	Zone 22

A measurement probe may only be used in dust or gas protected hazardous areas, even when there are approvals for both areas. For use in hazardous areas for dusts the maximum surface temperature of the sensor is specified. For the hazardous area for gases the ambient temperatures of the temperature classes are given. On request, EGE delivers sensors with special dimensions and special materials as well as longer connection cables.

Technique and application • IO-Link

Use IO-Link

Universal · Smart · Easy

IO-Link is an internationally standardised communication technology (IEC 61131-9) for the data exchange with sensors and actuators. IO-Link enables the continuous communication from the control down to the lowest field level to the sensor.

EGE is a member of the IO-Link group of companies organised within the PNO (Profibus user organisation). It develops the technology and supports the members and users in the integration of IO-Link enabled products.

The following description of the IO-Link technology explains the key terms and functions. Further information is available on the homepage of the IO-Link consortium: www.io-link.com.

Benefits

Cost reduction

Parametrisable sensors and actuators with a standardised interface reduce the multitude of device types required and reduce complexity during procurement.

Innovative machine concepts

Only a continuous communication with each sensor and actuator opens up all functions of intelligent devices. This permits the implementation of innovative machine and plant concepts.

Short commissioning times

IO-Link communication runs over unshielded cables and uses common industry connectors. The installation location can be optimised and the sensor later parametrised within the system. The complete parameter set can be stored in digital form and transmitted freely to additional devices.

Productivity

IO-Link devices automatically identify and parametrise themselves when changed (data storage). This simplifies the replacement of faulty components and reduces repair-related downtimes of machines and plant.

Maintenance

Intelligent IO-Link devices can be uniquely identified in the system, offer functions for self-diagnosis and supply data for the analysis of the system functionality. This permits novel preventative repair and maintenance concepts.

Parametrisation

IO-Link enabled sensors can comfortably be parametrised with a PC/Notebook, an IO-Link master and the corresponding software and can then be used as conventional sensors with switching and analogue output (SIO mode). Alternative their use is also possible as IO-Link devices which supply the sensor signals as process data to a control.

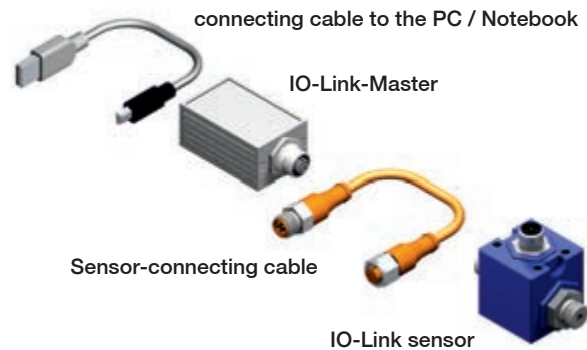

EGE IO-Link-System

System overview

An IO-Link system generally consists of the following components:

- IO-Link master
- IO-Link device (sensor/actuator)
- Unshielded 3 or 4 core cable
- Software for project planning and parametrisation of IO-Link devices

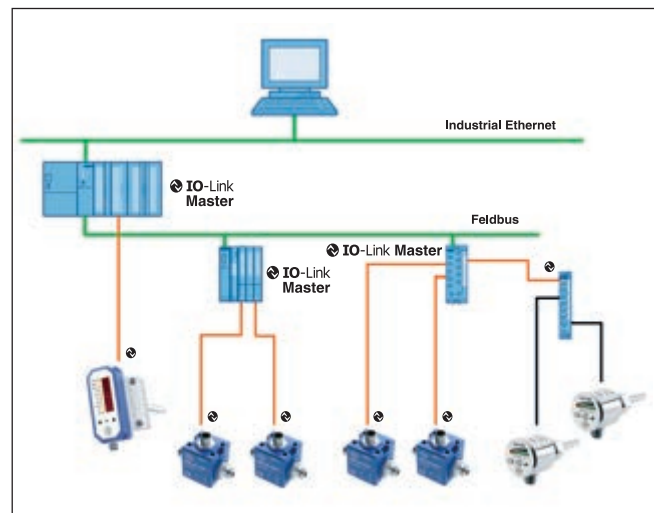

The IO-Link master provides the connection between the IO-Link sensor/actuator and the automation system. As part of a peripheral system the IO-Link master is either coupled directly to the PLC in the control cabinet or installed as remote I/O component with field bus connection in the machine or plant. Such masters have several channels which can each be connected to a device with IO-Link functionality.

Technique and application • IO-Link

IO-Link interface

IO-Link is a serial bidirectional point-to-point communication for the signal transmission and energy supply.

Connection technology in IP 65 / IP 67

For the connection technology in IP 65 / 67 e.g. M12 plug connectors have been defined. Sensors normally feature a 4 pin connector and actuators a 5 pin connector.

IO-Link masters normally feature a 5 pin M12 socket.

The connection assignment has been specified in IEC 60974-5-2 as follows:

- Pin 1 / L+ (BN): 24 V DC (IO-Link specification: 18...30 V DC)
- Pin 3 / L- (BU): 0 V
- Pin 4 / C/Q (BK): Switching (Q) and communication (C) line

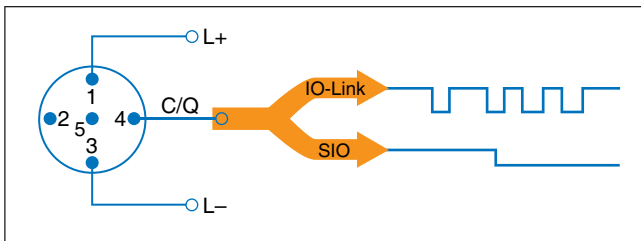

Connection type A

In type A the functional assignment for pin 2 and pin 5 is not defined by the IO-Link specification. The manufacturer can use these freely for additional output and input functions.

EGE uses pin 2 for an additional switching output, a 4...20 mA output or as signal input.

Connection cable

The connection cable of an IO-Link device to the master should according to the IO-Link specification not exceed a length of 20 m. An unshielded standard cable is sufficient.

IO-Link communication

Operating modes

The port (pin 4 / C/Q) of an IO-Link master can be operated in the following operating modes:

- IO-Link: Data transfer between device and master
- DI (digital input): The binary output state of the connected device is processed (the sensor output supplies a switching signal).
- DQ (digital output): At the output the corresponding high or low level is present (an actuator is actuated).
- Deactivated: No use has been assigned to the port.

Starting the I/O-Link communication

If the operating mode IO-Link is assigned to the port of an IO-Link master, the communication starts. The IO-Link master supplies a wake-up pulse and waits for the response of the IO-Link partner. After successfully establishing a connection, the master determines the data transmission rate of the device and starts the communication.

Transmission speed

The IO-Link specification V1.1 specifies three data transmission rates:

- COM 1: 4.8 kBd
- COM 2: 38.4 kBd
- COM 3: 230.4 kBd

An IO-Link device only supports one of the defined data transmission rates. An IO-Link master according to specification V1.1 supports all data transmission rates and automatically adjusts to the data transmission rate supported by the device.

Response time

The response time of an IO-Link system depends on the minimum cycle time of the device and the processing speed of the master. The device description file IODD includes a value for the minimum cycle time.

Transmission quality

The IO-Link communication utilises the 24 V level of the switching output for the transmission and is therefore highly interference-resistant. If the IO-Link software detects an error in the data transmission, this is repeated. Only after three consecutive failed attempts is the connection terminated. This termination is reported to the higher level control without delay as an error message.

Data types

Generally, four data types are available:

- Process data: Cyclic data
- Value status: Cyclic data
- Device data: Acyclic data
- Events: Acyclic data

Process data and value status

Process data and their value status are transmitted cyclically in a data telegram. The process data lengths has been defined with 0 to 32 bytes for each device in its specification by the manufacturer. The value status indicates whether the process data are value or invalid.

Device data

Device data may be parameters, identification data and diagnostic information. They are exchanged acyclically between the master and the device.

Events

If a previously defined event occurs in the device, the occurrence is reported to the master. The master then requests further information from the device and forwards the messages to the control. Events may be error messages and warnings. The IO-Link master can also transmit its own error messages and status data to the control.

The transmission of parameters or events is unaffected by the cyclical transmission of the process data.

Technique and application • IO-Link

Device profiles

Access from application programs to a device is standardised with IO-Link device profiles.

The device profiles define the data structure and content and the basic functionality. Different IO-Link devices are thus provided with a uniform user perspective and an identical program access by the control.

Smart sensor profile

In the IO-Link specification the "smart sensor profile" has currently been defined. It is particularly suited for measuring sensors, because in addition to the switching points measured values are also transmitted.

IODD device description file

The manufacturer provides for his IO-Link product an IODD (Input Output Device Description) in the form of XML files and images in digital form. The specified uniform structure of these files ensures the manufacturer-independent universal handling of the data. The IODD contain information about:

- Communication properties
- Device parameters with value ranges and default values
- Identification, process and diagnostic data
- Device data
- Text descriptions
- Device images
- Manufacturer logo

For devices which in addition to IO-Link version 1.0 also support version 1.1 there exist accordingly two different IODD versions.

IO-Link configuration tool

Software provided by the master manufacturer is required to configure an IO-Link system. This software uses the IODD for the communication and parametrisation of an IO-Link device. If multiple masters are used in control systems, the software has additional tasks:

- Assignment of the devices to the ports of the master
- Address allocation within the address range of the master

Technique and application • IO-Link

EGE products with IO-Link

EGE continuously expands its portfolio with sensors which include the IO-Link functionality. These can be integrated directly via the IO-Link interface in a control system and parametrised comfortably via this connection. As with all standard components, customer-specific special designs are also possible within the framework of the IO-Link specification for products with IO-Link interface.

IO-Link Master



With the IO-Link master the easy parametrisation of IO-Link enabled sensors is possible. The matching configuration software is available as download from www.iq2.development and can be installed on a PC or Notebook. The set includes in addition to the master and power supply also an M12 connection cable to the sensor and a USB cable for connection to the PC.

IO-Link-USB-Master-Set

Z01216

Flow rate measurement and monitoring with SDNC 500 GAPL / GANPL



for water-based media, linearized:

SDNC 502 GAPL	0.020...0.500 l/min • P11381
SDNC 503 GAPL	0.05...2.00 l/min • P11375
SDNC 506 GAPL	0.10...4.00 l/min • P11377
SDNC 508 GAPL	0.20...8.00 l/min • P11379

for water / glycol / oil, non linear:

SDNC 503 GANPL	0.0... ca. 6.0 l/min • P11376
SDNC 506 GANPL	0.0... ca. 15.0 l/min • P11378
SDNC 508 GANPL	0.0... ca. 30.0 l/min • P11380

SDNC 500 sensors with IO-Link interface are the smart solution for process monitoring. They can record the flow speed and temperature in fluid mediums. To do so, there is a configuration software which configures the sensors via an IO-Link/USB master. The ... GAPL models provide flow data for liquid mediums as a linear output signal. The detection range of sensors suitable for all liquid media can be freely configured. Their output signal is not linear.

Functions / parameters

- Limit value and range monitoring for flow rate and temperature
- Adjustable delay for the switching signal
- Analog output scalable for flow rate or temperature
- Pulse output for flow rate
- Logical linking of flow rate and temperature monitoring
- Teach commands for determining the limit and range values
- TAG identification programmable
- Available in the SIO mode analog and switching output

The flow rate sensors have a G1/4 process connection and can be easily integrated with hoses or pipe connectors in pipes. A special flow adapter shapes the flow profile and ensures a stable signal for the SDNC 502/503/506 GAPL. In the SDNC 508 GAPL a straight inlet section of 100 mm is sufficient to achieve the specifications. The measuring range of the ...GANPL variants can be adapted to almost all media. A non-linear signal path results. The robust construction makes the sensors not sensitive to moisture and vibrations.

Compressed air consumption measurement with LDN, LDV und LDS

The compressed air sensors LDN 1009, LDV 1025/1040 and LDS 1000 detect the flow rate, the temperature and the pressure (not LDN 1009) in compressed air networks. They display the current air flow rate of a connected tool or system in an easy-to-read display and respond quickly to any changes in flow speed. At the same time the sensors also act as volume meters and measure the air consumption in the units standard litre and standard cubic metre.



The parametrisation of the sensors is via the IO-Link interface or the buttons on the front panel. Its 6-digit display shows the measurement values which can be sent as process data to an SPS via the IO Link connection. In the IOS mode the user can use the configured analogue and switching outputs.

Functions / parameters

- Resettable compressed air consumption meter
- Limit value and range monitoring for all variables
- Adjustable delay of the switching signal
- Scalable analog output for all variables
- Selectable variable for display
- Selectable measuring unit for flow rate and consumption
- 24h average / max and min value readable for all variables
- Configurable outputs (PNP/NPN-NO/NC)
- Adjustable reference values for standard pressure and standard temperature
- TAG ID programmable and readable on device
- Modification counter (changes to the device configuration)
- In the SIO mode analogue and switching output or two switching outputs available

LDN 1009 GAPL



LDN 1009 GAPL

G1/4 • 15 Nm³/h • P11373

The functional principle of the compressed air sensor is calorimetric. Heat is removed from a sensor element by passing air and results in a temperature reduction. The amount of reduction is determined by the air mass and results in an output signal proportional to the mass flow. No pressure or temperature compensation is required for the medium state. According to factory configuration the flow rate is displayed directly in standard litres or standard cubic metres. The standard conditions for pressure and temperature can be adjusted in the application.

The sensor is inserted inline into the pipe line. The lengths for run-in and run-out distances required result from pipe routes and any existing controls and instruments upstream of the sensor. For the operation of the compressed air meters the air must be free from oil, filtered and dehumidified in accordance with class 1.4.1 as per ISO 8573-1.

LDV 1025 / LDV 1040



LDV 1025 GAPL
LDV 1040 GAPL

G1 • 420 Nm³/h • P11382
G1 1/2 • 750 Nm³/h • P11383

In these sensors the air flow causes in the area of the reduced diameter a vacuum compared to the inlet pressure. This pressure difference is a measure for the flow rate. The influence of the absolute pressure and the air temperature on the flow volume is taken into account by integrated measuring elements. The sensors are installed "inline" in the pipe. No special measures for dehumidification and filtering of the compressed air are required. To achieve the specified deviations, straight inlet and outlet sections without steps must be provided.

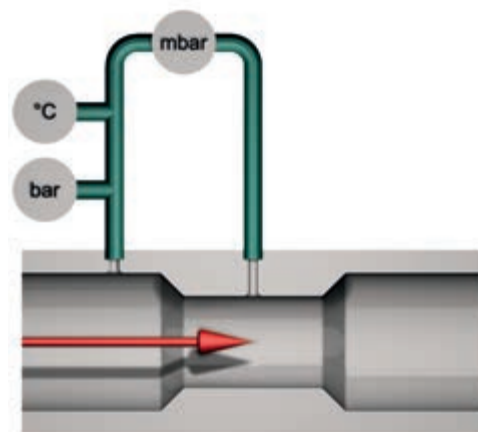

Outside the usual pressure ranges the consumption sensors also operate in the low pressure range with a limited functional scope. The optimum ranges of application (green area) for the variants LDV 1025 and LDV 1040 are shown in the diagrams below.

Technique and application • IO-Link

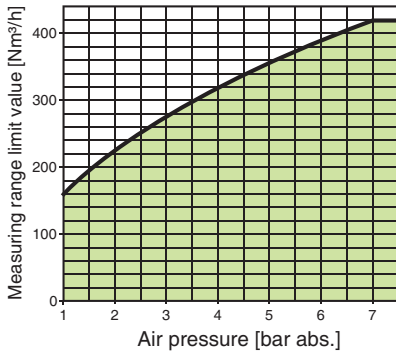

Working range LDV 1025 GAPT

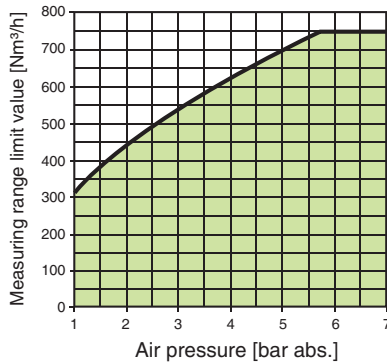

Working range LDV 1040 GAPT

LDS 1000



LDS 1000 GAPT

Usable up to d=200 mm • P11388

The LDS 1000 is used as immersion sensor in compressed air lines from DN 40. By entering the internal pipe diameter the measuring range limit value for the sensor is determined and the flow rate or air consumption indicated on the display. The measuring range related to the diameter is shown in the diagram below. Via the IO-Link interface the sensor supplies the flow rate data as a percentage value of the measuring range limit value. The limit value can be read as device parameter with the parametrisation software.

The air flow causes at the measuring point of this sensor which is overflow an overpressure compared to the downstream measuring aperture. This pressure difference is a measure for the flow rate. The influence of the absolute pressure and the air temperature on the flow volume is calculated by integrated measuring elements and taken into account when analysing the pressure difference.

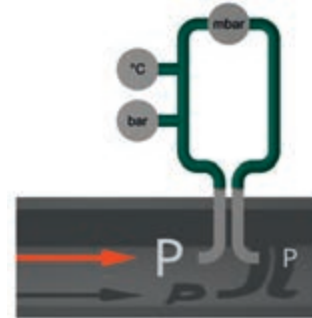
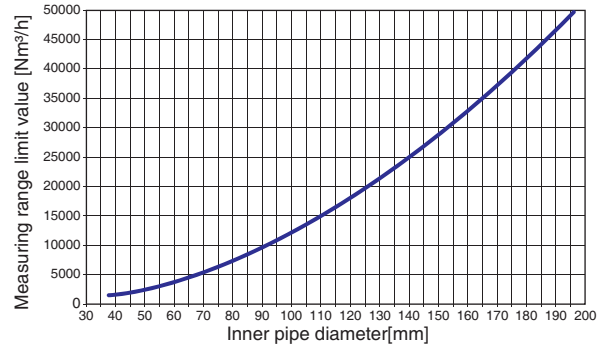

The sensor is installed with a cutting ring fitting in the pipe. The lengths for run-in and run-out distances required result from pipe routes and any existing controls and instruments upstream of the sensor.



Outside the usual pressure ranges the sensor also operates in the low pressure range with a limited application scope. The optimum functional range (green area) is shown in the diagram.

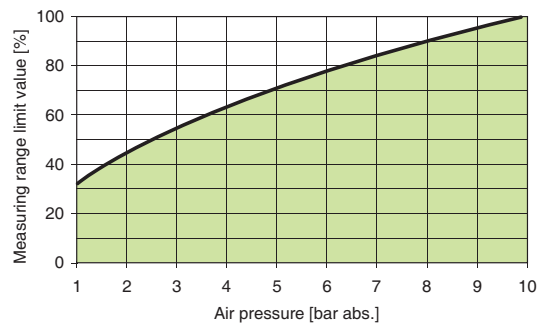

Working range LDS 1000 GAPT



Probes
Compact models
Amplifiers

Probe • Plug-in installation

Series ST 400

Connection thread
M18x1.5

Plug-in installation
Can be used universally with
an adapter

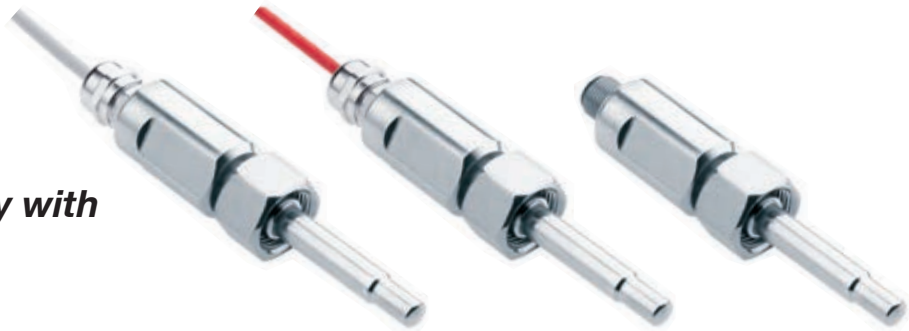

Design	M18x1.5		M18x1.5
Dimensions			
Detection range [cm/s]	Water 1...150		Oil 1...150
	Oil 3...300		Water 3...300
Sensor length L [mm]	47		47
ID-No.	P11354		P11355
Type	ST 418 S-A4		ST 418 K-A4
Medium temperature [°C]	-20...+80		+10...+120
Temperature gradient [K/min]	250		250
Start-up time typ. [s]	8 (2...15)		8 (2...15)
Reaction time typ. [s]	2 (1...13)		2 (1...13)
Compressive strength [bar]	100		100
Sensor material	AISI 316 Ti		AISI 316 Ti
Protection [EN 60529]	IP 67		IP 68
Connection	M12 connector		2 m PVC-cable 4x0.25 mm ²
Accessories	connecting cable type SLG, SLW (page 1.99), Screw-in adapter SDA-SCS-... (page 1.103)		

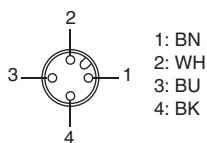

Amplifiers required: SKM..., SKZ..., see page 1.71 - 1.75

Probe • Standard thread

Series ST 400

G1/2 thread

Stainless steel

PTFE-Housing

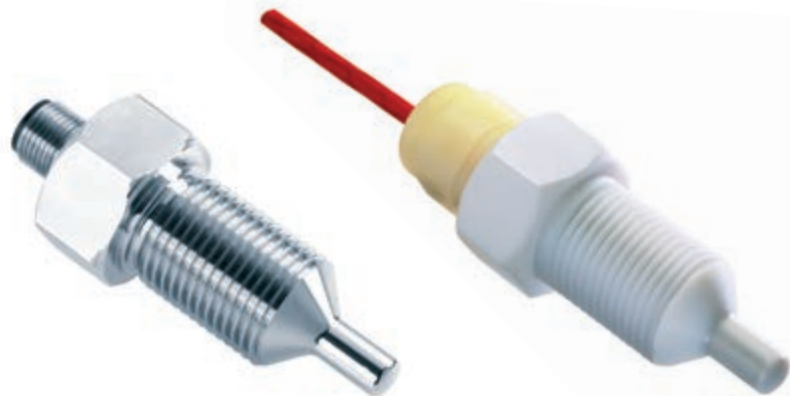

Design	G1/2	G1/2	G1/2 PTFE
Dimensions			
Detection range [cm/s]			
Water	1...150	1...150	1...70
Oil	3...300	3...300	2...100
Sensor length [mm]	48	48	48
ID-No.	P10412	P10414	P10431
Type	ST 421 K-A4	ST 421 S-A4	ST 421 K-F
Medium temperature [°C]	-20...+80		-10...+70
Temperature gradient [K/min]	250		1
Start-up time typ. [s]	8 (2...15)		60 (40...100)
Reaction time typ. [s]	2 (1...13)		30 (10...50)
Compressive strength [bar]	100		5
Sensor material	AISI 316 Ti • different material on request		PTFE
Protection [EN 60529]	IP 68	IP 67	IP 68
Connection	2 m PVC-cable 4x0.25 mm ²	M12 connector	2 m FEP-cable 4x0.25 mm ² cable gland PVDF

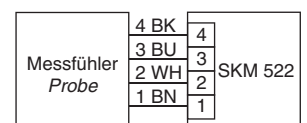
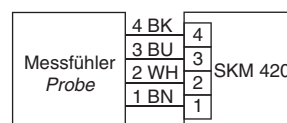
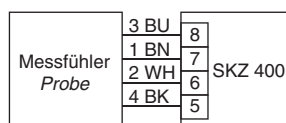
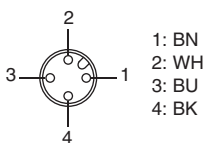

Amplifiers required: SKM..., SKZ..., see page 1.71 - 1.75

Accessories

connecting cable type SLG 4-2 (Z00445), SLW 4-2 (Z00446), see page 1.99

Probe • Short thread

Series STK 400

G1/4 thread

G1/2 thread

Stainless steel

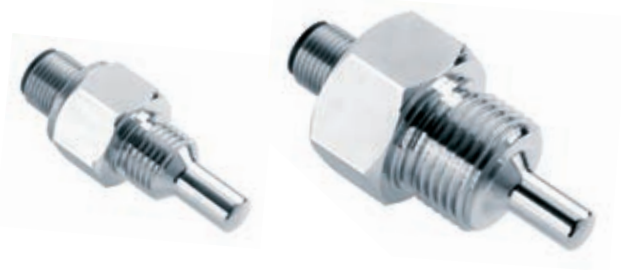

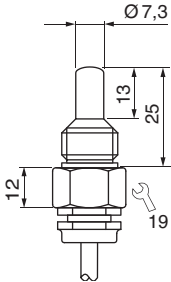
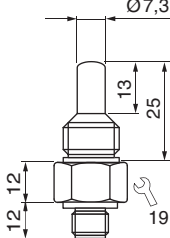
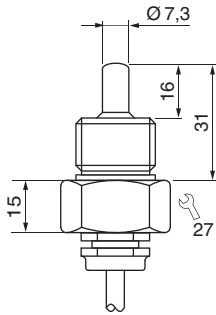
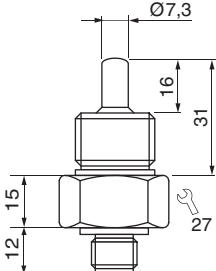
Design	G1/4	G1/4	G1/2	G1/2
Dimensions				
Detection range [cm/s]				
Water	1...150	1...150	1...150	1...150
Oil	3...300	3...300	3...300	3...300
Sensor length [mm]	25	25	31	31
ID-No.	P10402	P10404	P10408	P10410
Type	STK 412 K-A4	STK 412 S-A4	STK 421 K-A4	STK 421 S-A4
Medium temperature [°C]	-20...+80			
Temperature gradient [K/min]	250			
Start-up time typ. [s]	8 (2...15)			
Reaction time typ. [s]	2 (1...13)			
Compressive strength [bar]	100			
Sensor material	AISI 316 Ti • different material on request			
Protection [EN 60529]	IP 68	IP 67	IP 68	IP 67
Connection	2 m PVC-cable 4x0.25 mm ²	M12 connector	2 m PVC-cable 4x0.25 mm ²	M12 connector

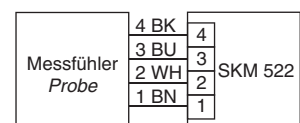
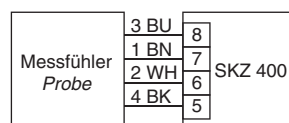
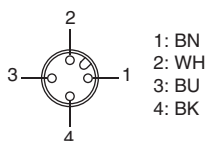

Amplifiers required: SKM..., SKZ..., see page 1.71 - 1.75

Accessories connecting cable type SLG 4-2 (Z00445), SLW 4-2 (Z00446), see page 1.99

Probe • Extra long

Series ST 400

G1/2 thread

Stainless steel



Design	G1/2		G1/2	
Dimensions				
Detection range [cm/s]	1...150 3...300		1...150 3...300	
Sensor length L [mm]	80	120	80	120
ID-No.	P10901	P10902	P10904	P10905
Type	ST 421 K-L80	ST 421 K-L120	ST 421 S-L80	ST 421 S-L120
Medium temperature [°C]	-20...+80			
Temperature gradient [K/min]	250			
Start-up time typ. [s]	8 (2...15)			
Reaction time typ. [s]	2 (1...13)			
Compressive strength [bar]	100			
Sensor material	AISI 316 Ti • different materials on request			
Protection [EN 60529]	IP 68		IP 67	
Connection	2 m PVC-cable 4x0.25 mm ²		M12 connector	

Extra long sensors up to 300 mm on request

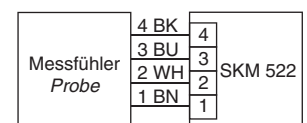
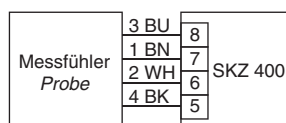
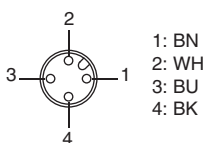

Amplifiers required: SKM..., SKZ..., see page 1.71 - 1.75

Accessories connecting cable type SLG 4-2 (Z00445), SLW 4-2 (Z00446), see page 1.99

Probe • High temperature 120 °C

Series ST 400

G1/4 thread

G1/2 thread

G3/4 thread

Stainless steel

High temperature sensors 120 °C

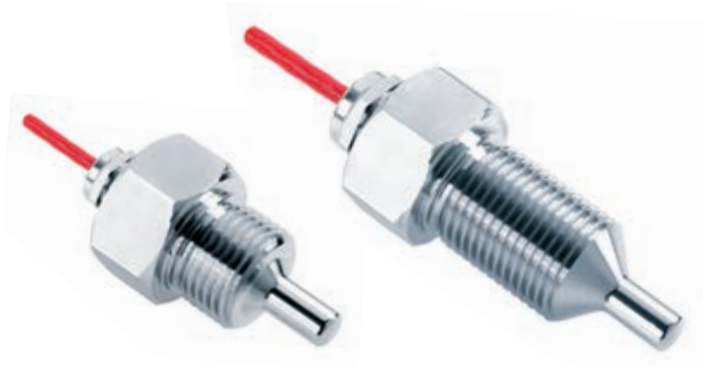

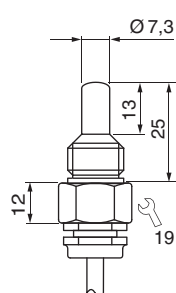
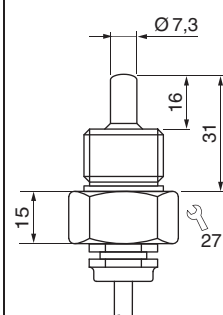
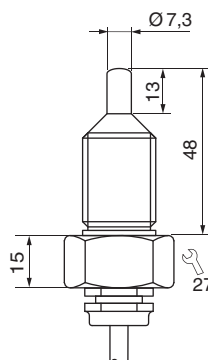
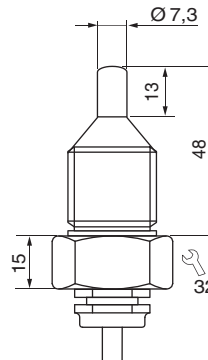
Design	G1/4	G1/2	G1/2	G3/4
Dimensions				
Detection range [cm/s]				
Water	1...150	1...150	1...150	1...150
Oil	3...300	3...300	3...300	3...300
Sensor length [mm]	25	31	48	48
ID-No.	P10435	P10436	P10437	P10438
Type	STK 412 KH-A4	STK 421 KH-A4	ST 421 KH-A4	ST 431 KH-A4
Medium temperature [°C]	+10...+120			
Temperature gradient [K/min]	250			
Start-up time typ. [s]	8 (2...15)			
Reaction time typ. [s]	2 (1...13)			
Compressive strength [bar]	100			
Sensor material	AISI 316 Ti • different materials on request			
Protection [EN 60529]	IP 68			
Connection	2 m FEP-cable, 4x0.25 mm ²			

High temperature sensors may be used for temperature up to 120 °C. A short-time overload up to 135 °C is allowed; within this time the switching point is not specified. After returning back to temperatures below 120 °C the sensor will work properly again. Special design on request.

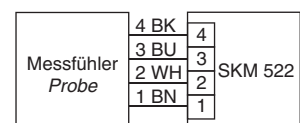
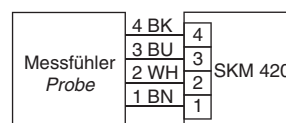
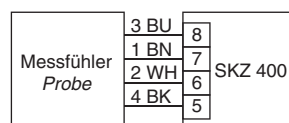

Amplifiers required: SKM..., SKZ..., see page 1.71 - 1.75

Probe • High temperature 160 °C

Series ST 500

G1/2 thread

Resistant to hot steam

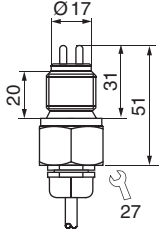
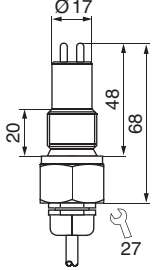
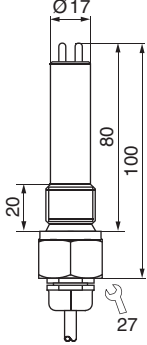

Design	G1/2		
Dimensions			
Detection range			
Fluids [cm/s]	1...300	1...300	1...300
Air / gas [m/s]	1...40	1...40	1...40
Sensor length [mm]	31	48	80
ID-No.	P11259	P11260	P11261
Type	ST 521 KH	ST 521/1 KH	ST 521/2 KH
Medium temperature [°C]	fluids +10...160 – air/gas +10...135		
Temperature gradient [K/min]	fluids 250 – air/gas 20		
Start-up time [s]	5...20		
Reaction time [s]	2...20		
Compressive strength [bar]	60		
Protection [EN 60529]	IP 67		
Sensor material	AISI 316 Ti • different materials on request		
Connection	2 m FEP-cable 4x0.25 mm ²		



Amplifier required: SKM 520, see page 1.73

Probe • Chemical resistant

Series STA 400

G1/2 thread

Hastelloy B-2/C-22

Metal ceramic coated



Design	G1/2...HB2/HC22		G1/2...K-B3	G1/2...S-B3
Dimensions				
Detection range [cm/s]				
Water	1...150		1...150	1...150
Oil	3...300		3...300	3...300
Sensor length [mm]	31		34	34
ID-No.	P10625		P10623	P10622
Type	STA 421 K-HB2		STA 421 K-B3	STA 421 S-B3
Medium temperature [°C]	-20...+80 (+10...+120 on request)			
Temperature gradient [K/min]	250			
Reaction time [s]	1...15			
Compressive strength [bar]	100			
Sensor material	Hastelloy B-2	Hastelloy C-22	Titanium / metal ceramic	
Protection [EN 60529]	IP 68			IP 67
Connection	2 m FEP-cable 4x0.25 mm ²			M12 connector
			<p>These sensors are made of titanium and are coated with a metal-ceramic material layer. Coated sensors display chemical resistance practically comparable to chemical characteristics of PTFE or Hastelloy. Unlike PTFE sensors, coated sensors display the same temperature behaviour as stainless steel sensors, with high temperature gradients.</p> <p>The high surface hardness of the coating protects the sensor against abrasion, thus considerably increasing its durability. The perfectly smooth surface virtually eliminates deposits.</p>	
	<p>1: BN 2: WH 3: BU 4: BK</p>			
	<p>Amplifiers required: SKM..., SKZ..., see page 1.71 - 1.75</p>			
Accessories	connecting cable type SLG 4-2 (Z00445), SLW 4-2 (Z00446), see page 1.99			

Compact models DC-PNP • Screw-in mounting

Series SC 440

DC 24 V

Stainless steel

G1/4 thread

G1/2 thread

NPT 1/2 thread



Design	G1/4		G1/2			NPT1/2
Dimensions						
Detection range [cm/s]	water 1...150 / oil 3...300					
Output						
Sensor length L [mm]	25	31	48	80	120	40
Thread	G1/4	G1/2	G1/2	G1/2	G1/2	NPT1/2
ID-No.	P11064 *	P10521 *	P10523 *	P10525 *	P10526 *	P11066 *
Type	SC440/5-A4-GSP	SC440-A4-GSP	SC440/1-A4-GSP	SC440/2-A4-GSP	SC440/3-A4-GSP	SC440/6-A4-GSP
Supply voltage [V]	24 DC ±20%					
Current consumption [mA]	70					
Switching current [mA]	400 (20 °C)					
Ambient temperature [°C]	-20...+80					
Medium temperature [°C]	-20...+80					
Temperature gradient [K/min]	250					
Start-up time typ. [s]	8 (2...15)					
Reaction time typ. [s]	2 (1...13)					
Compressive strength [bar]	100					
Sensor material	AISI 316 Ti • different materials on request					
Housing material	AISI 316 Ti / AISI 303					
Display flow	LED-array					
Protection [EN 60529]	IP 67					
Connection	M12 connector					
* US LISTED E304328						
Accessories	connecting cable type SLG 3-2, SLG 3-5, SLW 3-2, SLW 3-5, see page 1.99					

Compact models DC-PNP • Plug-in installation

Series SCS 440

DC 24 V

Robust stainless steel housing

Connection thread M18x1.5

Can be used universally
with an adapter



Design	M18x1.5
Dimensions	
Detection range [cm/s]	water 1...150 / oil 3...300
Output	PNP
Sensor length L [mm]	47
Thread fixing nut	M18x1.5
ID-No.	P11352
Type	SCS 440-A4-GSP
Supply voltage [V]	24 DC ±20%
Current consumption [mA]	≤70
Switching current [mA]	400 (20 °C)
Ambient temperature [°C]	-20...+80
Medium temperature [°C]	-20...+80
Temperature gradient [K/min]	250
Start-up time typ. [s]	8 (2...15)
Reaction time typ. [s]	2 (1...13)
Compressive strength [bar]	100
Material	housing: AISI 316 L sensor: AISI 316 Ti
O-Ring-Material	FPM
Display flow	LED-array
Protection [EN 60529]	IP 67
Connection	M12 connector

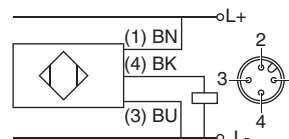

Accessories connecting cable type SLG, SLW (page 1.99), screw-in adapter SDA-SCS-... (page 1.103)

Compact models AC/DC • Plug-in installation

Series SNS 450

AC 230 V • AC 115 V • DC 24 V

PNP output • Relay output

Connection thread M18x1.5

Can be used universally
with an adapter



Design	M18x1.5			
Dimensions				
Detection range [cm/s]	water 1...150 / oil 3...300			
Output	PNP		Relay	
Sensor length L [mm]	47	47	47	47
Connection thread G	M18x1.5	M18x1.5	M18x1.5	M18x1.5
ID-No.	P11360*	P11362*	P11364*	P11365*
Type	SNS 450-A4-GSP-S	SNS 450-A4-GR	SNS 450-A4-WR1	SNS 450-A4-WR2
Supply voltage [V]	24 DC ±20%	24 DC ±20%	115 AC ±10%	230 AC ±10%
Current consumption [mA]	<100	<100	<65	<35
Switching voltage max. [V]	-	250 AC / 60 DC	250 AC / 60 DC	250 AC / 60 DC
Switching current max. [A]	0.4 (20°C)	4 AC / 4 DC	4 AC / 4 DC	4 AC / 4 DC
Switching power max.	-	1000 VA / 60 W	1000 VA / 60 W	1000 VA / 60 W
Ambient temperature [°C]	-20...+70			
Medium temperature [°C]	-20...+80			
Temperature gradient [K/min]	250			
Start-up time typ. [s]	8 (2...15)			
Reaction time typ. [s]	2 (1...13)			
Compressive strength [bar]	100			
Sensor material	AISI 316 Ti			
Housing material	PBT			
Display flow	LED array			
Protection [EN 60529]	IP 67			
Connection	M12 connector		2 m PVC-cable 5x0.5 mm ²	
* US LISTED E304328				
Accessories	connecting cable type SLG, SLW (page 1.99), screw-in adapter SDA-SCS-... (page 1.103)			



Compact models DC-PNP • Screw-in mounting

Series SN 450

DC 24 V

G1/2 thread

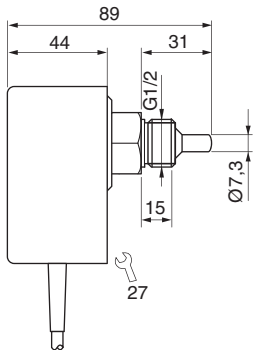
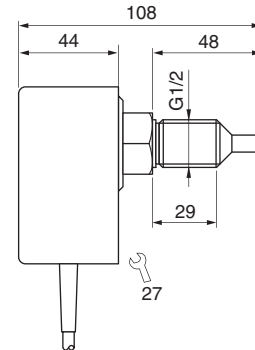

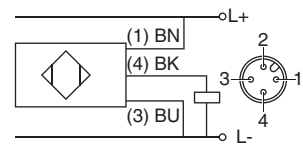
Design	G1/2 • L= 31 mm		G1/2 • L= 48 mm	
Dimensions				
Detection range [cm/s]	water 1...150 / oil 3...300			
Output	 PNP			
Sensor length L [mm]	31	31	48	48
Thread	G1/2	G1/2	G1/2	G1/2
ID-No.	P11241 *	P11161 *	P11228 *	P11162 *
Type	SN 450-A4-GSP	SN 450-A4-GSP-S	SN 450/1-A4-GSP	SN 450/1-A4-GSP-S
Supply voltage [V]	24 DC ±20%			
Current consumption [mA]	60			
Switching current [mA]	400 (20 °C)			
Ambient temperature [°C]	-20...+70			
Medium temperature [°C]	-20...+80			
Temperature gradient [K/min]	250			
Start-up time typ. [s]	8 (2...15)			
Reaction time typ. [s]	2 (1...13)			
Compressive strength [bar]	100			
Sensor material	AISI 316 Ti • different materials on request			
Housing material	PBT			
Display flow	LED-array			
Protection [EN 60529]	IP 67			
Connection	2 m PVC-cable 3x0.5 mm ²	M12 connector	2 m PVC-cable 3x0.5 mm ²	M12 connector
*  US LISTED E304328				
Accessories	connecting cable type SLG 3-2, SLG 3-5, SLW 3-2, SLW 3-5, see page 1.99			

Compact models DC-Relay • Screw-in mounting

Series SN 450

DC 24 V

G1/2 thread



Design	G1/2 • L= 31 mm / 48 mm		G1/2 • L= 31 mm / 48 mm	
Dimensions				
Detection range [cm/s]	water 1...150 / oil 3...300			
Output	Relay		Relay	
Sensor length L [mm]	31	48	31	48
Thread	G1/2	G1/2	G1/2	G1/2
ID-No.	P11115	P11078	P11116	P11086
Type	SN 450-A4-GR	SN 450/1-A4-GR	SN 450-A4-GRS	SN 450/1-A4-GRS
Supply voltage [V]	24 DC ±20%			
Current consumption [mA]	80			
switching voltage [V]	250 AC / 60 DC		30 AC / 36 DC	
Switching current [mA]	4 A AC / 4 A DC		1 A AC / 1 A DC	
Switching power max.	1000 VA / 60 W		-	
Ambient temperature [°C]	-20...+70			
Medium temperature [°C]	-20...+80			
Temperature gradient [K/min]	250			
Start-up typ. [s]	8 (2...15)			
Reaction time typ. [s]	2 (1...13)			
Compressive strength [bar]	100			
Sensor material	AISI 316 Ti • different materials on request			
Housing material	PBT			
Display flow	LED-array			
Protection [EN 60529]	IP 67			
Connection	2 m PVC-cable 5x0.5 mm ²		M12 connector	
Accessories	connecting cable type SLG 4-2, SLG 4-5, SLW 4-2, SLW 4-5, see page 1.99			

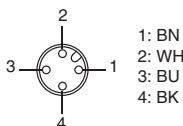

Compact models AC-Relay • Screw-in mounting



Series SN 450

AC 230 V • AC 115 V

Relay output

G1/2 thread

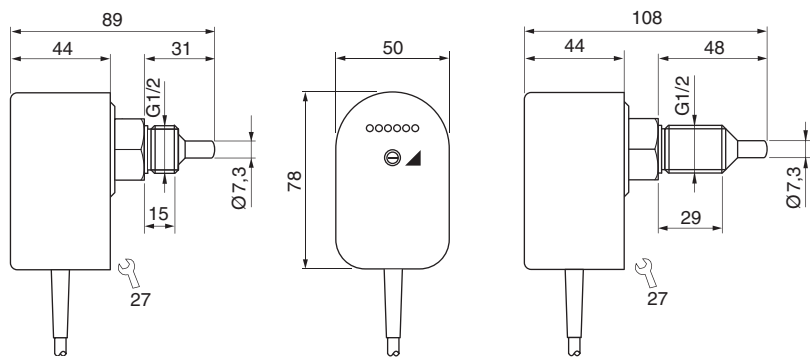

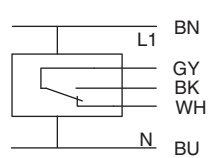
Design	G1/2 • L= 31 mm		G1/2 • L= 48 mm	
Dimensions				
Detection range [cm/s]	water 1...150 / oil 3...300			
Output	 Relay			
Sensor length L [mm]	31	31	48	48
Thread	G1/2	G1/2	G1/2	G1/2
ID-No.	P11113	P11114	P11074	P11076
Type	SN 450-A4-WR1	SN 450-A4-WR2	SN 450/1-A4-WR1	SN 450/1-A4-WR2
Supply voltage [V]	115 AC ±15%	230 AC ±15%	115 AC ±15%	230 AC ±15%
Current consumption [mA]	60	30	60	30
Switching voltage [V]	250 AC / 60 DC			
Switching current [mA]	4 A AC / 4 A DC			
Switching power max.	1000 VA / 60 W			
Ambient temperature [°C]	-20...+70			
Medium temperature [°C]	-20...+80			
Temperature gradient [K/min]	250			
Start-up time typ. [s]	8 (2...15)			
Reaction time typ. [s]	2 (1...13)			
Compressive strength [bar]	100			
Sensor material	AISI 316 Ti • different materials on request			
Housing material	PBT			
Display flow	LED-array			
Protection [EN 60529]	IP 67			
Connection	2 m PVC-cable 5x0.5 mm ²			
				

Compact models AC/DC • Extra long

Series SN 450

AC 230 V • AC 115 V

DC 24 V

Relay output

G1/2 thread



Design	G1/2 • L= 80 mm			G1/2 • L= 120 mm		
Dimensions						
Detection range [cm/s]	water 1...150 / oil 3...300					
Output	 Relay					
Sensor length L [mm]	80	80	80	120	120	120
Thread	G1/2	G1/2	G1/2	G1/2	G1/2	G1/2
ID-No.	P11079	P11080	P11081	P11082	P11083	P11084
Type	SN450/2-A4-WR1	SN450/2-A4-WR2	SN450/2-A4-GR	SN450/3-A4-WR1	SN450/3-A4-WR2	SN450/3-A4-GR
Supply voltage [V]	115 AC ±15%	230 AC ±15%	24 DC ±20%	115 AC ±15%	230 AC ±15%	24 DC ±20%
Current consumption [mA]	60	30	80	60	30	80
Switching voltage [V]	250 AC / 60 DC					
Switching current [mA]	4 A AC / 4 A DC					
Switching power max.	1000 VA / 60 W					
Ambient temperature [°C]	-20...+70					
Medium temperature [°C]	-20...+80					
Temperature gradient [K/min]	250					
Start-up time typ. [s]	8 (2...15)					
Reaction time typ. [s]	2 (1...13)					
Compressive strength [bar]	100					
Sensor material	AISI 316 Ti • different materials on request					
Housing material	PBT					
Display flow	LED-array					
Protection [EN 60529]	IP 67					
Connection	2 m PVC-cable 5x0.5 mm ²					

Compact models DC-Analog • Plug-in installation

Series SNS 450



DC 24 V

Analog output 4...20 mA

Connection thread M18x1,5

Can be used universally
with an adapter

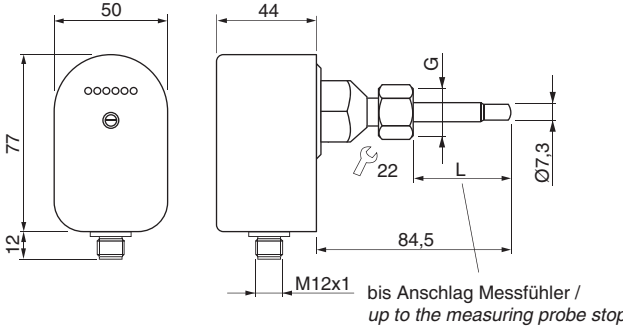
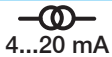

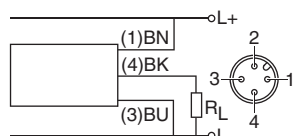
Design	M18x1.5		
Dimensions	 <p>bis Anschlag Messfühler / up to the measuring probe stop</p>		
Detection range [cm/s]			
Water	5...150	5...300	1...150
Oil	-	-	3...300
Output	 <p>4...20 mA</p>		
Sensor length L	47	47	47
Connection thread G	M18x1.5	M18x1.5	M18x1.5
ID-No.	P11357 *	P11358 *	P11359 *
Type	SNS 450 GA	SNS 450 GA-3M	SNS 450 GAN-S
Supply voltage [V]	24 DC ±10%		
Current consumption [mA]	< 100		
Current output [mA]	4...20, linear	4...20, linear	4...20, non linear
Load R _L [Ω]	200...500		
Ambient temperature [°C]	-20...+70		
Medium temperature [°C]	-20...+80		
Start-up time typ. [s]	8...60		
Reaction time typ. [s]	3		
Compressive strength [bar]	100		
Sensor material	AISI 316 Ti		
Housing material	PBT		
Display flow	LED-array		
Protection [EN 60529]	IP 67		
Connection	M12 connector		
*  US LISTED E304328			
Accessories	connecting cable type SLG, SLW (page 1.99), screw-in adapter SDA-SCS-... (page 1.103)		

Compact models DC-Analog • Screw-in mounting

Series SN 450

DC 24 V

Analog output 4...20 mA

G1/2 thread



Design	G1/2 • L= 31 mm		G1/2 • L= 48 mm		
Dimensions					
Detection range [cm/s]	Water	Oil	Water	Oil	Water
Output	5...150	5...300	5...150	5...300	5...150 3...300
Sensor length L [mm]	31	31	48	48	48
Thread	G1/2	G1/2	G1/2	G1/2	G1/2
ID-No.	P11121 *	P11118 *	P11095 *	P11122 *	P11239 *
Type	SN 450 GA	SN 450 GA-3M	SN 450/1 GA	SN 450/1 GA-3M	SN 450/1 GAN-S
Supply voltage [V]	24 DC ±10%				
Current consumption [mA]	< 100				
Current output [mA]	4...20, linear				4...20, non linear
Load R _L [Ω]	200...500				
Ambient temperature [°C]	-20...+70				
Medium temperature [°C]	-20...+80				
Start-up time typ. [s]	8...60				
Reaction time typ. [s]	3				
Compressive strength [bar]	100				
Sensor material	AISI 316 Ti • different materials on request				
Housing material	PBT				
Display flow	LED-array				
Protection [EN 60529]	IP 65				
Connection	M12 connector				

* US LISTED
E304328

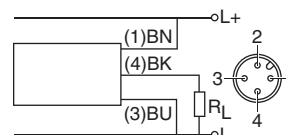

Accessories connecting cable type SLG 3-2 (Z01076), see page 1.99

Compact models DC-2x PNP • Screw-in mounting

Series SN 450



DC 24 V

PNP output

G1/2 thread

Two independent switching points

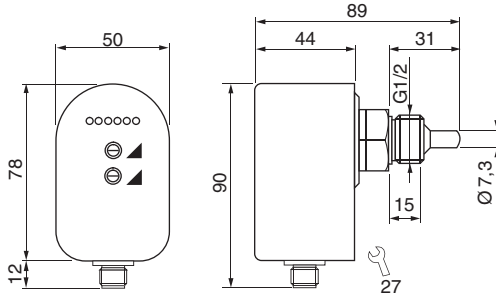
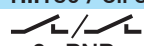

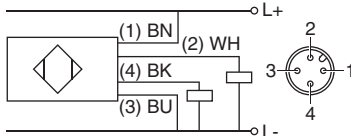
Design	G1/2 • L= 31 mm	
Dimensions		
Detection range	[cm/s]	water 1...150 / oil 3...300
Output		 2x PNP
Sensor length L	[mm]	31
Thread		G1/2
ID-No.		P11264 *
Type		SN 450 GPP
Supply voltage	[V]	24 DC ±20%
Current consumption	[mA]	< 60
Switching current	[mA]	200 (20 °C) each output
Ambient temperature	[°C]	-20...+60
Medium temperature	[°C]	-20...+80
Temperature gradient	[K/min]	250
Start-up time typ.	[s]	8 (2...15)
Reaction time typ.	[s]	2 (1...13)
Compressive strength	[bar]	100
Sensor material		AISI 316 Ti • different materials on request
Housing material		PBT
Display flow		LED-array
Protection	[EN 60529]	IP 67
Connection		M12 connector
*  US LISTED E304328		
Accessories		connecting cable type SLG 4-2 (Z00445), see page 1.99

Compact models DC • Temperature control

Series SNT 450

DC 24 V

PNP output

G1/2 thread



Design	G1/2 • L= 31 mm		G1/2 • L= 48 mm	
Dimensions				
Detection range [cm/s]	water 1...150 / oil 3...300			
Output	 2x PNP			
Sensor length L [mm]	31	31	48	48
Temperature [°C]	0...+80	0...+80	0...+80	0...+80
ID-No.	P11218*	P11219*	P11224*	P11225*
Type	SNT 450-A4-GSP	SNT 450-A4-GSP-S	SNT 450/1-A4-GSP	SNT 450/1-A4-GSP-S
Supply voltage [V]	24 DC ±20%			
Current consumption [mA]	< 60			
Switching current [mA]	200 (20 °C) each output			
Ambient temperature [°C]	-20...+70			
Medium temperature [°C]	-20...+80			
Temperature gradient [K/min]	250			
Start-up time typ. [s]	8 (2...15)			
Reaction time typ. [s]	2 (1...13)			
Compressive strength [bar]	100			
Sensor material	AISI 316 Ti • different materials on request			
Housing material	PBT			
Display flow	LED-array			
Protection [EN 60529]	IP 65			
Connection	2 m PVC-cable 4x0.5 mm ²	M12 connector	2 m PVC-cable 4x0.5 mm ²	M12 connector

* US LISTED
E304328

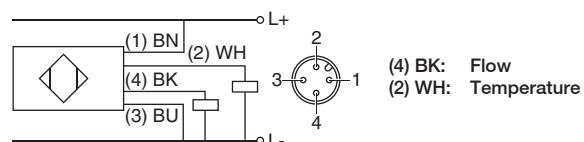

Accessories connecting cable type SLG 4-2, SLG 4-5, SLW 4-2, SLW 4-5, see page 1.99

Compact models DC • Temperature control

Series SNT 450

DC 24 V

Relay output

G1/2 thread



Design	G1/2 • L= 31 mm		G1/2 • L= 48 mm	
Dimensions				
Detection range [cm/s]	water 1...150 / oil 3...300			
Output	 Relay			
Sensor length L [mm]	31	31	48	48
Temperature [°C]	0...+80	0...+80	0...+80	0...+80
ID-No.	P11216	P11217	P11222	P11223
Type	SNT 450-A4-GR	SNT 450-A4-GR-S	SNT 450/1-A4-GR	SNT 450/1-A4-GR-S
Supply voltage [V]	24 DC ±20%	24 DC ±20%	24 DC ±20%	24 DC ±20%
Current consumption [mA]	80	80	80	80
Switching voltage [V]	250 AC / 60 DC	30 AC / 36 DC	250 AC / 60 DC	30 AC / 36 DC
Switching current [mA]	2A AC / 2A DC	1A AC / 1A DC	2A AC / 2A DC	1A AC / 1A DC
Switching power max.	500 VA / 60 W	-	500 VA / 60 W	-
Ambient temperature [°C]	-20...+70			
Medium temperature [°C]	-20...+80			
Temperature gradient [K/min]	250			
Start-up time typ. [s]	8 (2...15)			
Reaction time typ. [s]	2 (1...13)			
Compressive strength [bar]	100			
Sensor material	AISI 316 Ti • different materials on request			
Housing material	PBT			
Display flow	LED-array			
Protection [EN 60529]	IP 65			
Connection	2 m PVC-cable 6x0.5 mm ²	M12 connector	2 m PVC-cable 6x0.5 mm ²	M12 connector
Accessories	connecting cable type SLG 5-2, SLW 5-2, see page 1.99			

Compact models AC • Temperature control

Serie SNT 450

AC 230 V • 115 V

Relay output

G1/2 thread



Design	G1/2 • L= 31 mm		G1/2 • L= 48 mm	
Dimensions				
Detection range [cm/s]	water 1...150 / oil 3...300			
Output	 Relay			
Sensor length L [mm]	31	31	48	48
Temperature [°C]	0...+80	0...+80	0...+80	0...+80
ID-No.	P11214	P11215	P11220	P11221
Type	SNT 450-A4-WR1	SNT 450-A4-WR2	SNT 450/1-A4-WR1	SNT 450/1-A4-WR2
Supply voltage [V]	115 AC ±15%	230 AC ±15%	115 AC ±15%	230 AC ±15%
Current consumption [mA]	60	30	60	30
Switching voltage [V]	250 AC / 60 DC			
Switching current [A]	2 AC / 2 DC			
Switching power max.	500 VA / 60 W			
Ambient temperature [°C]	-20...+70			
Medium temperature [°C]	-20...+80			
Temperature gradient [K/min]	250			
Start-up time typ. [s]	8 (2...15)			
Reaction time typ. [s]	2 (1...13)			
Compressive strength [bar]	100			
Sensor material	AISI 316 Ti • different materials on request			
Housing material	PBT			
Display flow	LED-array			
Protection [EN 60529]	IP 65			
Connection	2 m PVC-cable 6x0.5 mm ²			

Compact models AC/DC • Turn on/off delay



Series SN 450

AC 230 V • DC 24 V

Relay output

G1/2 thread

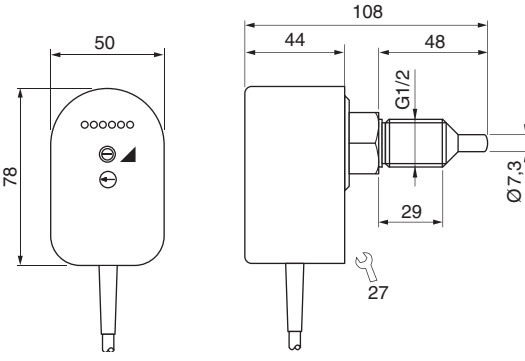

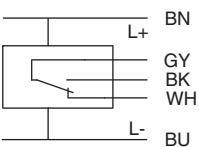
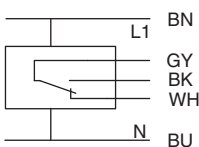
Design	Turn on delay		Turn off delay	
Dimensions				
Detection range [cm/s]	water 1...150 / oil 3...300			
Output	 Relay			
ID-No.	P11234	P11233	P11231	
Type	SN 450/1 GR-VE	SN 450/1 GR-VA	SN 450/1 WR2-VA	
Turn on delay [s]	0...25	-	-	
Turn off delay [s]	-	0...25	0...25	
Supply voltage [V]	24 DC ±20%	24 DC ±20%	230 AC ±15%	
Current consumption [mA]	<80	<80	30	
Switching voltage [V]	250 AC / 60 DC			
Switching current [A]	2 AC / 2 DC			
Switching power max.	500 VA / 60 W			
Ambient temperature [°C]	-20...+70			
Medium temperature [°C]	-20...+80			
Temperature gradient [K/min]	250			
Start-up time typ. [s]	8 (2...15)			
Reaction time typ. [s]	2 (1...13)			
Compressive strength [bar]	100			
Sensor material	AISI 316 Ti • different materials on request			
Housing material	PBT			
Display flow	LED-array			
Protection [EN 60529]	IP 65			
Connection	2 m PVC-cable, 5x0.5 mm ²			
				

Inline-Probes

Series SD 500

Pipe diameter $\varnothing 4$ mm / $\varnothing 9$ mm

G1/4 thread



Design		G1/4 • $\varnothing 4$ mm	G1/4 • $\varnothing 9$ mm
Dimensions			
Detection range	[l/min]	0.001...1	0.01...6
Working range	[l/min]	0.01...0.8	0.2...6
Inner diameter d	[mm]	4	9
ID-No.		P11251	P11252
Type		SD 504 S	SD 510 S
Ambient temperature	[°C]	-20...+70	
Medium temperature	[°C]	0...+80	
Temperature gradient	[K/min]	400	
Start-up time	[s]	5	
Reaction time typ.	[s]	0.5...10	
Compressive strength	[bar]	20	
Material		housing: PBT sensor: AISI 316 Ti	
Protection	[EN 60529]	IP 67	
Connection		M12 connector	

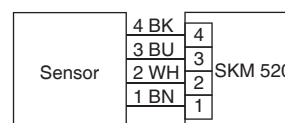
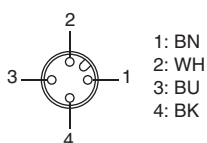

Amplifiers required: SKM 520, page 1.73
(Temperature control with this sensor is not possible)

Accessories connecting cable type SLG 4-2 (Z00445), see page 1.99

Inline-Compact • up to 6 l/min

Series SDN 500

DC 24 V

PNP output







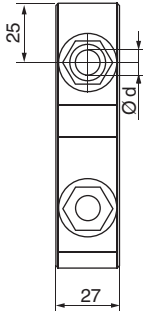
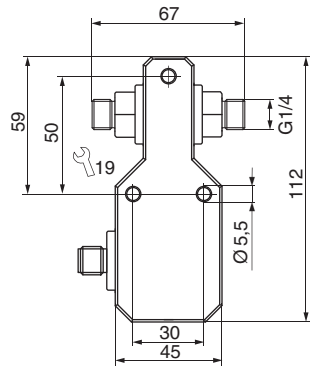

Relay output

Analog output

G1/4 thread • Ø4 mm

G1/4 thread • Ø9 mm

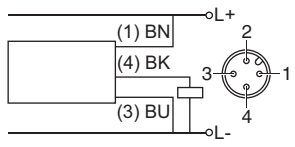
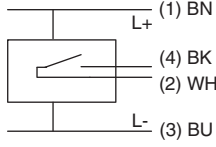
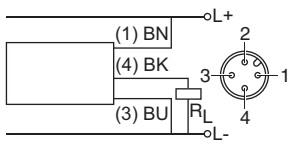

Design	G1/4 • Ø4 mm			G1/4 • Ø9 mm		
Dimensions						
Detection range [l/min]	0.001...1			0.01...6		
Working range [l/min]	0.015...1			0.1...6		
Inner diameter d [mm]	4			9		
Maximum flow [l/h]	300			1800		
Output						
ID-No.	P11247*	P11271	P11249*	P11248*	P11273	P11250*
Type	SDN 504 GSP	SDN 504 GR	SDN 504 GA	SDN 510 GSP	SDN 510 GR	SDN 510 GA
Supply voltage [V]	24 DC ±10%					
Current consumption [mA]	< 50					
Switching voltage [V]	-	30 AC/36 DC	-	-	30 AC/36 DC	-
Switching current [mA]	200 (20 °C)	1000	-	200	1000	-
Load R _L [Ω]	-	-	200...500	-	-	200...500
Ambient temperature [°C]	0...+60					
Medium temperature [°C]	0...+80					
Temperature gradient [K/min]	400 (> 0.1 l/min)			400 (> 0.5 l/min)		
Start-up time typ. [s]	5...15					
Reaction time typ. [s]	0.5...10					
Compressive strength [bar]	20					
Display flow	LED-array					
Material	housing: PBT sensor: AISI 316 Ti					
Protection [EN 60529]	IP 67					
Connection	M12 connector					
*  US LISTED E304328						
Accessories	connecting cable type SLG, SLW, SBG, SBW, see page 1.99					

Inline-Compact • up to 40 l/min

Series SDN 500

DC 24 V

PNP output







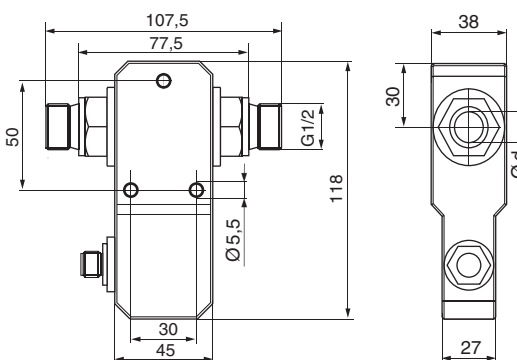
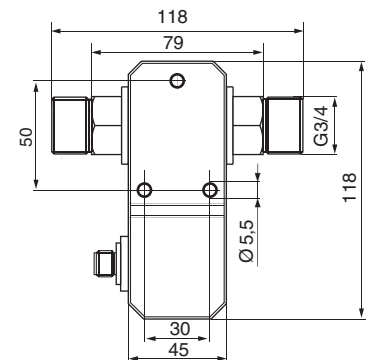

Relay output

Analog output

G1/2 thread • Ø 15 mm

G3/4 thread • Ø 19 mm

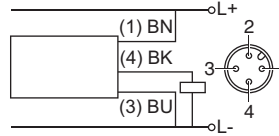
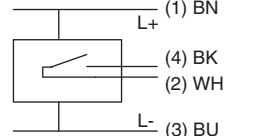
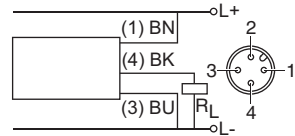

Design	G1/2 • Ø 15 mm			G3/4 • Ø 19 mm		
Dimensions						
Detection range [l/min]	2...25			3...40		
Working range [l/min]	3...20			4...30		
Inner diameter d [mm]	15			19		
Maximum flow [l/h]	4000			7500		
Output						
ID-No.	P11284 *	P11288	P11286 *	P11285 *	P11289	P11287 *
Type	SDN 515 GSP	SDN 515 GR	SDN 515 GA	SDN 520 GSP	SDN 520 GR	SDN 520 GA
Supply voltage [V]	24 DC ±10%					
Current consumption [mA]	< 50					
Switching voltage [V]	-	30 AC/36 DC	-	-	30 AC/36 DC	-
Switching current [mA]	200 (20 °C)	1000	-	200 (20 °C)	1000	-
Load R _L [Ω]	-	-	200...500	-	-	200...500
Ambient temperature [°C]	0...+60					
Medium temperature [°C]	0...+80					
Temperature gradient [K/min]	400 (> 7 l/min)			400 (> 10 l/min)		
Start-up time typ. [s]	5...15					
Reaction time typ. [s]	0.5...10					
Compressive strength [bar]	20					
Display flow	LED-array					
Material	housing: PBT sensor: AISI 316 Ti / FPM					
Protection [EN 60529]	IP 67					
Connection	M12 connector					
*  US LISTED E304328						
Accessories	connecting cable type SLG, SLW, SBG, SBW, see page 1.99					

Inline-Compact • Micro flow

Series SDN 500

DC 24 V

PNP output • Relais output





Analog output

G1/4 thread

Detection of micro flow pulses

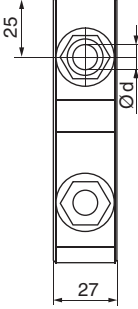
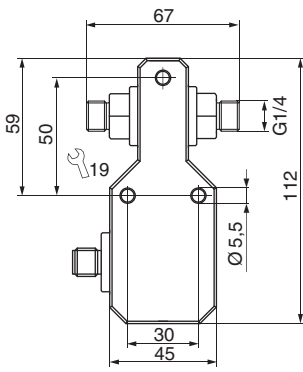
Fast reaction time - high sensitivity

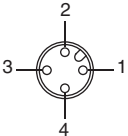
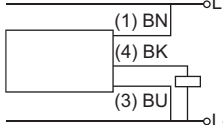
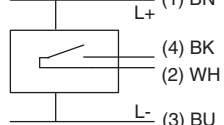

Design	G1/4 pulse detection		G1/4	
Dimensions				
Detection range [ml/min]	ab 0.02 ml/100 ms		0.1...500	
Working range [ml/min]	ab 0.04 ml/100 ms		1...200	
Inner diameter d [mm]	4		3.6	
Maximum flow [l/h]	300		100	
Output	 PNP		 Relay 4...20 mA, non linear	
ID-No.	P11372 *		P11330	
Type	SDN 503/1 GSP-DYN		SDN 503/1 GR	
Supply voltage [V]	24 DC ±10%		24 DC ±10%	
Current consumption [mA]	< 50		< 50	
Switching voltage [V]	-		30 AC/36 DC	
Switching current [mA]	200 (20 °C)		1000	
Load R _L [Ω]	-		-	
Ambient temperature [°C]	0...+60		0...+60	
Medium temperature [°C]	-20...+80		0...+60	
Temperature gradient [K/min]	-		400 (> 100 ml/min)	
Start-up time [s]	5...15		5...60	
Reaction time [s]	< 0.1		0.5...10	
Compressive strength [bar]	20		10	
Display flow	LED-array			
Material	housing: PBT sensor: AISI 316 Ti			
Protection [EN 60529]	IP 67			
Connection	M12 connector			
*  E304328 	The SDN 503/1 GSP-DYN detects increasing in flow. The switch-off delay is adjustable between 0.5...10 s			
				
Accessories	connecting cable type SLG, SLW, SBG, SBW, see page 1.99			

Inline-Compact • Micro flow

Series SDN 500

DC 24 V

PNP output • Relais output

Analog output

Ø4 mm

Ø6 mm for tube fittings

Fast reaction time - high sensitivity



Design	Tube connection Ø4 mm			Tube connection Ø6 mm		
Dimensions						
Detection range [ml/min]	0.1...500					
Working range [ml/min]	1...200					
Inner diameter d [mm]	inner diameter 3.6 / outer diameter 4.0			inner diameter 3.6 / outer diameter 6.0		
Maximum flow [l/h]	100			100		
Output						
ID-No.	P11265 *	P11277	P11266 *	P11332 *	P11333	P11334 *
Type	SDN 503 GSP	SDN 503 GR	SDN 503 GA	SDN 503/2 GSP	SDN 503/2 GR	SDN 503/2 GA
Supply voltage [V]	24 DC ±10%					
Current consumption [mA]	<50					
Switching voltage [V]	-	30 AC/36 DC	-	-	30 AC/36 DC	-
Switching current [mA]	200 (20 °C)	1000	-	200 (20 °C)	1000	-
Load R _L [Ω]	-	-	200...500	-	-	200...500
Ambient temperature [°C]	0...+60					
Medium temperature [°C]	0...+60					
Temperature gradient [K/min]	400 (>100 ml/min)					
Start-up time [s]	5...60					
Reaction time typ. [s]	0.5...10					
Compressive strength [bar]	1			10		
Display flow	LED-array					
Material	housing: PBT sensor: AISI 316 Ti					
Protection [EN 60529]	IP 67					
Connection	M12 connector					
* US LISTED E304328						
Accessories	connecting cable type SLG, SLW, SBG, SBW, see page 1.99					

Inline-Compact





Series SDNC 503

DC 24 V

Flow monitoring

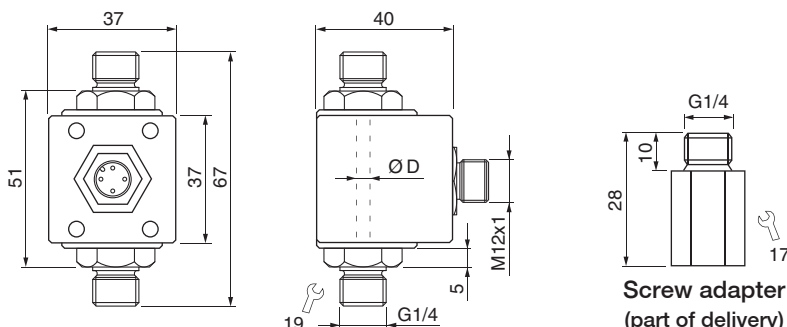
Can be easily integrated in the tubing
Immediately ready for use - no adjustment

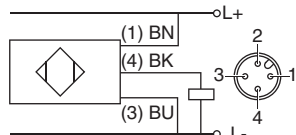

Design	G1/4 • Ø3.6 mm		
Dimensions			
Switching point [l/min]	water 0,5	water 1,0	water 1,5
Inner diameter D [mm]	3.6	3.6	3.6
Output	 PNP	 PNP	 PNP
ID-No.	P11338	P11340	P11341
Type	SDNC 503 GSP-05	SDNC 503 GSP-10	SDNC 503 GSP-15
Supply voltage [V]	24 DC ±10%		
Current consumption [mA]	≤ 70		
Switching current [mA]	200		
Ambient temperature [°C]	0...+60		
Medium temperature [°C]	0...+60		
Reaction time typ. [s]	1 (0.5...10)		
Compressive strength [bar]	10		
Sensor material	AISI 316 Ti		
Housing material	PBT-GF30		
Protection [EN 60529]	IP 67		
Connection	M12 connector		
			
Accessories	connecting cable type SLW 3-2-LED, page 1.99		

Inline-Compact

Series SDNC 503

DC 24 V

Flow monitoring of
50 up to 2000 ml/min

Can be easily integrated in the tubing
Immediately ready for use - no adjustment



Design	G1/4 • Ø3.6 mm			
Dimensions				
Detection range [l/min]	water 0.05...1.0	water 0.2...2.0	water 0.05...1.0	water 0.2...2.0
Inner diameter D [mm]	3.6	3.6	3.6	3.6
Output	4...20 mA, linear	4...20 mA, linear	pulse, linear	pulse, linear
ID-No.	P11342	P11343	P11344	P11345
Type	SDNC 503 GA-10	SDNC 503 GA-20	SDNC 503 GP-10	SDNC 503 GP-20
Supply voltage [V]	24 DC ±10%			
Current consumption [mA]	≤ 70			
Load R _L [Ω]	200...500	200...500	≥ 1000	≥ 1000
Pulse output [ml/Puls]	-	-	1	1
Ambient temperature [°C]	0...+60			
Medium temperature [°C]	0...+60			
Reaction time typ. [s]	1 (0.5...10)			
Compressive strength [bar]	10			
Sensor material	AISI 316 TI			
Housing material	PBT-GF30			
Protection [EN 60529]	IP 67			
Connection	M12 connector			
Accessories	connecting cable type SLG, SLW, page 1.99			

Inline-Compact • with IO-Link

Series SDNC 500 GANPL

Monitoring of flow and temperature

Configurable via IO-Link

Detection range adjustable
for all liquid media



Design	G1/4		
Dimensions			
Detection range	depending on medium		
Water / Glycol / Oil [l/min]	0...2 / 5 / 6	0...4 / 10 / 15	0...8 / 20 / 30
Inner diameter D [mm]	3.5	5.5	7.5
Output	/ / / IO-Link PNP-NO/NC 150 mA (20 °C) / 4...20 mA / IO-Link		
ID-No.	P11376	P11378	P11380
Type	SDNC 503 GANPL	SDNC 506 GANPL	SDNC 508 GANPL
Process data			
Flow [Steps]	0...1023		
Temperature [°C x 0.1]	0...600		
Supply voltage [V]	18...30 DC		
Current consumption [mA]	≤ 40		
Load (4...20 mA) [Ω]	200...500		
Ambient temperature [°C]	0...+60		
Medium temperature [°C]	0...+60		
Reaction time [s]	0.5...10		
Adjustable parameters	output functions, switching points, range, average value, teach-commands		
IO-Link-Specifications	revision 1.1, baud rate COM 2, min. cycle time 3.5 ms, process data 4 Byte		
Compressive strength [bar]	10		
Material	housing: PBT-GF30 sensor: AISI 316 Ti		
Protection [EN 60529]	IP 67		
Connection	M12 connector		

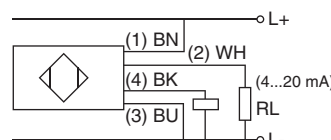

Accessories	mounting bracket (Z01215), IO-Link/USB master set (Z01216), page 1.98
-------------	---

Inline-Compact • with IO-Link

Series SDNC 500 GAPL

Monitoring of flow and temperature

Configurable via IO-Link

Linearized for water-based media



Design	G1/4			
Dimensions				
Detection range	linearized for water-based media			
Water [l/min]	0.020...0.500	0.05...2.00	0.10...4.00	0.20...8.00
Inner diameter D [mm]	3.6	3.6	5.5	7.5
Output				
ID-No.	P11381	P11375	P11377	P11379
Type	SDNC 502 GAPL	SDNC 503 GAPL	SDNC 506 GAPL	SDNC 508 GAPL
Process data				
Flow [l/min x 0.001]	0...500			
[l/min x 0.01]		0...200	0...400	0...800
Temperature [°C x 0.1]	0...600	0...600	0...600	0...600
Supply voltage [V]	18...30 DC			
Current consumption [mA]	≤ 40			
Load [Ω]	200...500			
Ambient temperature [°C]	0...+60			
Medium temperature [°C]	0...+60			
Reaction time [s]	0.5...10			
Adjustable parameters	output functions, switching points, range, average value, teach-commandos			
IO-Link-Specifications	revision 1.1, baud rate COM 2, min. cycle time 3.5 ms, process data 4 Byte			
Compressive strength [bar]	10			
Material	housing: PBT-GF30 sensor: AISI 316 Ti			
Protection [EN 60529]	IP 67			
Connection	M12 connector			
Note: Screw adapter is part of delivery (except P11379)				
Accessories	mounting bracket (Z01215), IO-Link/USB master set (Z01216), page 1.98			

Special-Probe • Food • Pharma

Series SCB / STB / STC

DC 24 V-PNP

Compact model

Triclamp Ø50.5

DIN 11851



Design	Triclamp compact	Triclamp Ø50.5	DIN 11851
Dimensions			
Detection range [cm/s]			
Water	1...150	1...150	1...150
Oil	3...300	3...300	3...300
Output			
Connecting diameter	Ø50.5 mm	Ø50.5 mm	DN 25
ID-No.	P11156	P11060	P10632
Type	SCB 450 GSP	STB 450 K	STC 425 K
Surface roughness [µm]	≤ 0.8		≤ 0.8
Supply voltage [V]	24 DC ±20%		-
Current consumption [mA]	<70		-
Switching current [mA]	200 (20 °C)		-
Ambient temperature [°C]	-20...+80		-20...+80
Medium temperature [°C]	-20...+80		+20...+120
Temperature gradient [K/min]	250		250
Start-up time [s]	8 (2...15)		8 (2...15)
Reaction time typ. [s]	2 (1...13)		2 (1...13)
Compressive strength [bar]	100		100
Housing material	AISI 316 L		AISI 316 L / PVDF (cable gland)
Protection [EN 60529]	IP 67		IP 68
Connection	M12 connector		2 m FEP-cable 4x0.25 mm ²
For sealing a 3A-compliant seal must be used.			
Accessories	conn. cable SLG, SLW		amplifiers: SKM..., SKZ..., page 1.71 - 1.75

Inline-Compact • Food • Pharma

Series SDB 500

DC 24 V

PNP output

Relay output

Analog output

Triclamp connection Ø34 mm

Inner diameter Ø10 mm



Design	Triclamp • Ø10 mm		
Dimensions			
Detection range [l/min]	0,01...6		
Working range [l/min]	0,1...6		
Inner diameter [mm]	10		
Maximum flow [l/h]	1800		
Output			
ID-No.	P11258 *	P11279	P11280 *
Type	SDB 510 GSP	SDB 510 GR	SDB 510 GA
Supply voltage [V]	24 DC ±10%		
Current consumption [mA]	< 50		
Switching voltage [V]	-	30 AC/36 DC	-
Switching current [mA]	200 (20 °C)	1000	-
Load R _L [Ω]	-	-	200...500
Ambient temperature [°C]	0...+60		
Medium temperature [°C]	-20...+80	-20...+80	-20...+60
Temperature gradient [K/min]	400		
Start-up time typ. [s]	5...15		
Reaction time typ. [s]	0.5...10		
Compressive strength [bar]	20		
Display flow	LED-array		
Material	housing: PBT sensor: AISI 316 L		
Protection [EN 60529]	IP 67		
Connection	M12 connector		
* US LISTED E304328			
For sealing a 3A-compliant seal must be used.			
Accessories	connecting cable type SLG, SLW, SBG, SBW, see page 1.99		

Inline-Compact • Chemical

Series SDN 500

DC 24 V

PNP output

Relay output

Analog output

G1/4 thread • Ø6 mm

Ceramic measuring cell • Metal free



Design	G1/4 • Ø6 mm		
<i>Dimensions</i>			
Detection range [l/min]	0.005...3		
Working range [l/min]	0.02...3		
Inner diameter [mm]	6		
Maximum flow [l/h]	300		
Output	 PNP	 Relay	 4...20 mA, non linear
ID-No.	P11262 *	P11275	P11263 *
Type	SDN 506 GSP-CER	SDN 506 GR-CER	SDN 506 GA-CER
Supply voltage [V]	24 DC ±10%		
Current consumption [mA]	-	< 50	-
Switching voltage [V]	-	30 AC/36 DC	-
Switching current [mA]	200	1000	-
Load R _L [Ω]	-	-	200...500
Ambient temperature [°C]	0...+60		
Medium temperature [°C]	0...+60		
Temperature gradient [K/min]	400		
Start-up time [s]	5...15		
Reaction time typ. [s]	0.5...10		
Compressive strength [bar]	5		
Display flow	LED-array		
Material	housing: PBT sensor: AL ₂ O ₃ / PTFE / FPM (different materials on request)		
Protection [EN 60529]	IP 67		
Connection	M12 connector		
* US LISTED E304328			
Accessories	connecting cable type SLG, SLW, SBG, SBW, see page 1.99		

Inline-Compact • Digital display • up to 40 l/min

Series SDN 550



Flow and temperature monitoring
of water and water-glycol mixtures

Programmable

2x PNP output

Analog output

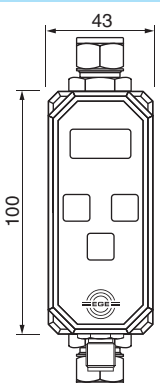
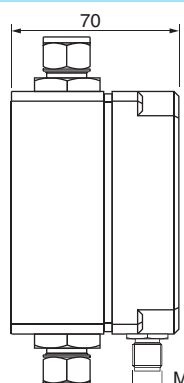
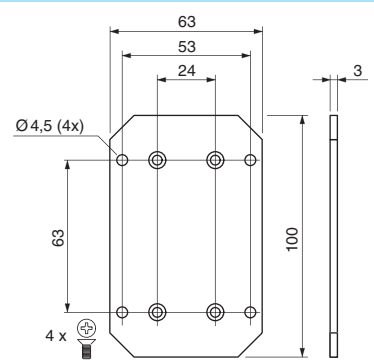
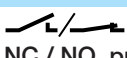
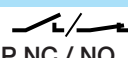

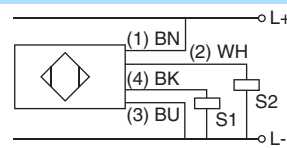
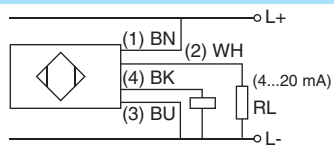
Design	SDN 552... GPP			SDN 552... GAPP		
Dimensions						
Medium	water / glycol (0, 5, ..., 25, 30%)					
Working range [l/min]	1...10	2...20	4...40	1...10	2...20	4...40
Outer diameter pipe [mm]	10	15	18	10	15	18
Pipe connection	tube fittings for steel tubes accord. to DIN 2391 / ISO 3304					
Output 1	2x  PNP NC / NO, progr.			 PNP NC / NO, progr. +  4...20 mA, linear		
Output 2						
ID-No.	P11293	P11294	P11295	P11296	P11297	P11298
Type	SDN 552/1 GPP	SDN 552/2 GPP	SDN 552/3 GPP	SDN 552/1 GAPP	SDN 552/2 GAPP	SDN 552/3 GAPP
Supply voltage [V]	24 DC ±10%			24 DC ±10%		
Current consumption [mA]	<100			<100		
Switching current [mA]	200 (20 °C)			200 (20 °C)		
Load R _L [Ω]	-			200...500		
Ambient temperature [°C]	0...+60					
Medium temperature [°C]	-10...+90					
Start-up time [s]	6...10					
Reaction time [s]	1...8					
Programmable functions	switching point, hysteresis, switching output, time on/off delay, glycol percentage, adjustable to reference, averaging, access code					
Temperature control [°C]	-10...90, alternative switching point					
Compressive strength [bar]	20					
Material	housing: PBT sensor: AISI 316 Ti / FKM					
Protection [EN 60529]	IP 65					
Connection	M12 connector					
						
Accessories	mounting plate, connecting cable type SLG, SLW (page 1.99), adapter G1/2, adapter G1/4 (page 1.103)					

Inline-Compact • Digital display • 1 l/min

Series SDN 550

Flow and temperature monitoring of water

Programmable

PNP output

Analog output

G1/4 thread

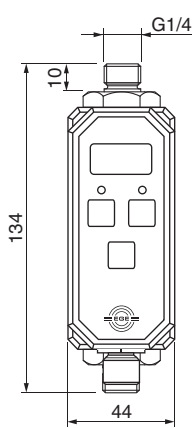
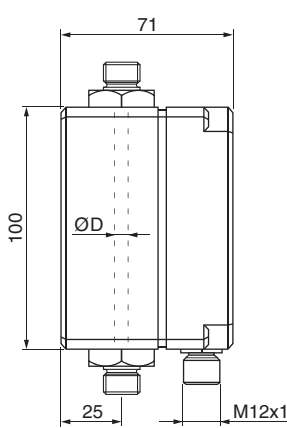
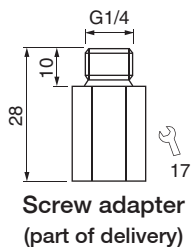
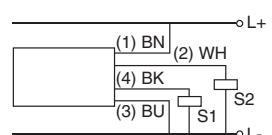
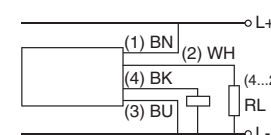
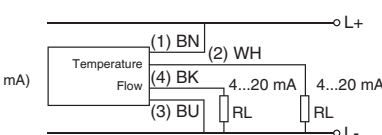

Design	SDN 552/5 GPP	SDN 552/5 GAPP	SDN 552/5 GAA
Dimensions			
Medium	water		
Working range [ml/min]	50...1000		
Inner diameter D [mm]	3.6		
Output 1	PNP NC / NO, progr.	PNP NC / NO, progr.	4...20 mA, linear
Output 2	PNP NC / NO, progr.	4...20 mA, linear	4...20 mA, linear
ID-No.	P11346	P11348	P11350
Type	SDN 552/5 GPP	SDN 552/5 GAPP	SDN 552/5 GAA
Supply voltage [V]	24 DC ±10%		
Current consumption [mA]	≤ 100		
Switching current [mA]	200 (20 °C)	200 (20 °C)	-
Load R _L [Ω]	-	200...500	200...500
Ambient temperature [°C]	0...+60		
Medium temperature [°C]	0...+60		
Start-up time [s]	6...10		
Reaction time [s]	1...8		
Programmable functions	switching point, hysteresis, NC/NO, time on/off delay, adjustable to reference, analog range, averaging, access code		
Compressive strength [bar]	10		
Material	housing: PBT sensor: AISI 316 Ti / FKM		
Protection [EN 60529]	IP 65		
Connection	M12 connector		
			
Accessories	mounting plate (Z01178), connecting plate type SLG, SLW, page 1.99		

Inline-Compact • Digital display • 2 l/min

Series SDN 550

Flow and temperature monitoring of water

Programmable

PNP output

Analog output

G1/4 thread



Design	SDN 552/6 GPP	SDN 552/6 GAPP	SDN 552/6 GAA
Dimensions	<p>Screw adapter (part of delivery)</p>		
Medium	water		
Working range [ml/min]	100...2000		
Inner diameter D [mm]	5,6		
Output 1	PNP NC / NO, progr.	PNP NC / NO, progr.	4...20 mA, linear
Output 2	PNP NC / NO, progr.	4...20 mA, linear	4...20 mA, linear
ID-No.	P11347	P11349	P11351
Type	SDN 552/6 GPP	SDN 552/6 GAPP	SDN 552/6 GAA
Supply voltage [V]	24 DC ±10%		
Current consumption [mA]	< 100		
Switching current [mA]	200 (20 °C)	200 (20 °C)	-
Load R _L [Ω]	-	200...500	200...500
Ambient temperature [°C]	0...+60		
Medium temperature [°C]	0...+60		
Start-up time [s]	6...10		
Reaction time [s]	1...8		
Programmable functions	switching point, hysteresis, NC/NO, time on/off delay, adjustable to reference, analog range, averaging, access code		
Compressive strength [bar]	10		
Material	housing: PBT sensor: AISI 316 Ti / FKM		
Protection [EN 60529]	IP 65		
Connection	M12 connector		
Accessories	mounting plate (Z01178), connecting plate type SLG, SLW, page 1.99		

Inline-Compact • Digital display • 100 l/min

Series SDN 550



Flow and temperature monitoring
of water

Programmable

Analog outputs

G3/4 thread

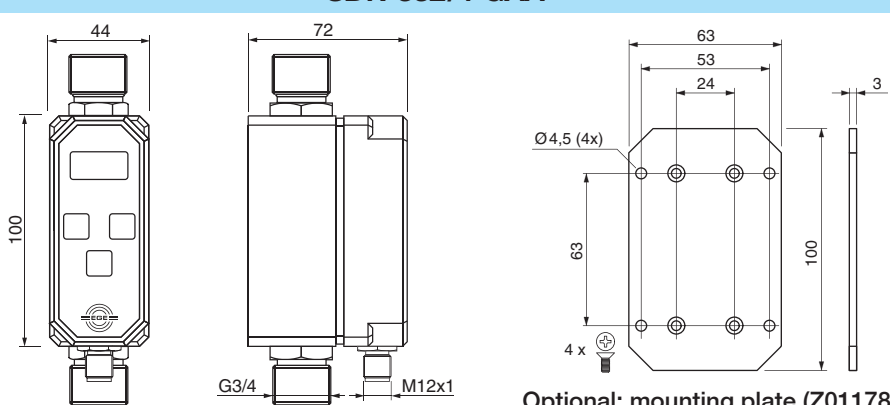

Design	SDN 552/4 GAA	
Dimensions	 <p>Optional: mounting plate (Z01178)</p>	
Medium	water	
Detection range	flow water: 10...100 l/min	temperature: 0...+90 °C
Connection	G3/4	
Output	flow:  4...20 mA, linear	temperature:  4...20 mA, linear
ID-No.	P11335	
Type	SDN 552/4 GAA	
Supply voltage [V]	24 DC ±10%	
Current consumption [mA]	< 100	
Load R _L [Ω]	200...500	
Ambient temperature [°C]	0...+60	
Medium temperature [°C]	0...+60	
Start-up time [s]	6...10	
Reaction time [s]	1...8	
Programmable functions	adjustable to reference, averaging, display flow / temperature, access code	
Compressive strength [bar]	20	
Material	housing: PBT sensor: AISI 316 Ti / FKM	
Protection [EN 60529]	IP 65	
Connection	M12 connector	
Accessories	mounting plate (Z01178), connecting cable type SLG, SLW, page 1.99	

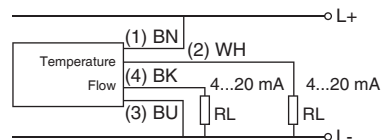

Inline-Compact • Digital display • up to 40 l/min

Series SDN 550

Flow and temperature monitoring
of water and water-glycol mixtures

Programmable

2x PNP output flow

2x PNP output temperature

2x Analog output



Design	SDN 554... GPP			SDN 552... GAA		
Dimensions						
Medium	water / glycol (0, 5, ..., 25, 30%)					
Working range [l/min]	1...10	2...20	4...40	1...10	2...20	4...40
Outer diameter pipe [mm]	10	15	18	10	15	18
Pipe connection	tube fittings for steel tubes accord. to DIN 2391 / ISO 3304					
Output flow	2x PNP NC / NO, progr.			4...20 mA, linear		
Output temperature	2x PNP NC / NO, progr.			4...20 mA, linear		
ID-No.	P11313	P11314	P11315	P11316	P11317	P11318
Type	SDN 554/1 GPP	SDN 554/2 GPP	SDN 554/3 GPP	SDN 552/1 GAA	SDN 552/2 GAA	SDN 552/3 GAA
Supply voltage [V]	24 DC ±10%					
Current consumption [mA]	<100					
Switching current [mA]	100 (20 °C) each output					
Load R _L [Ω]	-					
Ambient temperature [°C]	0...+60					
Medium temperature [°C]	-10...+90					
Temperature gradient [K/min]	400					
Start-up time [s]	6...10					
Reaction time [s]	1...8					
Programmable functions	glycol percentage, adjustable to reference, averaging, access code. only SDN 554: switching point, hysteresis, switching output, time on/off delay					
Temperature control [°C]	-9.8...90, 2 switching points			-10...90, analog, programmable		
Compressive strength [bar]	20					
Material	housing: PBT sensor: AISI 316 Ti / FKM					
Protection [EN 60529]	IP 65					
Connection	M12 connector					
Accessories	mounting plate, connecting cable type SLG, SLW (page 1.99), adapter G1/2, adapter G1/4 (page 1.103)					

Vortex-Measuring device • Digital display

Series SDV 600



Flow measuring of water

Deviation 2% of terminal value

Programmable

Analog and PNP output

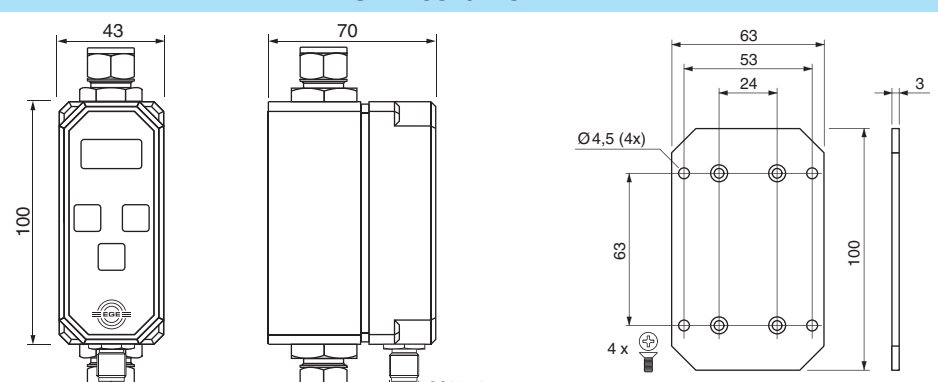

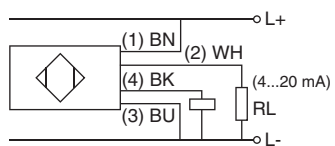
Design	SDV 652/1 GAPP	
Dimensions		
Working range	[l/min]	2...20
Maximum flow	[l/min]	25
Precision		15...50 °C <2%, 5...60 °C <4%
Outer diameter pipe	[mm]	10
Pipe connection		tube fittings for steel tubes accord. to DIN 2391 / ISO 3304
Output		 PNP NC / NO, programmable  4...20 mA, linear
ID-No.		P11319
Type		SDV 652/1 GAPP
Switching current	[mA]	200
Load R _L	[Ω]	200...500
Supply voltage	[V]	24 DC ±10%
Current consumption	[mA]	<100
Ambient temperature	[°C]	0...+60
Medium temperature	[°C]	5...+60
Start-up time	[s]	4.5...8
Reaction time	[s]	0.5...4
Programmable functions		switching point, hysteresis, switching output, time on/off delay, averaging, access code
Compressive strength	[bar]	10
Material		housing: PBT sensor: PVDF, connection AISI 316 Ti
Protection	[EN 60529]	IP 65
Connection		M12 connector
Note:	Process-connection in PTFE available	
		
Accessories	mounting plate, connecting cable type SLG, SLW (page 1.99), adapter G1/4 (page 1.103)	

Magnetic flowmeter • Digital display

Series SDI 850 - Magnetic flowmeter

Measurement error <2%

Programmable

Analog and PNP output



Design	SDI... GAPP	
Dimensions		
Working range [l/min]	0...40	0.2...80
Measurement error	0...5.0 l/min ≤0.1 l/min 5...40 l/min ≤2% of measurement value*	0...10.0 l/min ≤0.2 l/min 10.1...80 l/min ≤2% of measurement value*
ID-No.	P11320	P11321
Type	SDI 852/1 GAPP	SDI 852/2 GAPP
Outer diameter pipe [mm]	10	15
Pipe connection	tube fittings for steel tubes accord. to DIN 2391 / ISO 3304	
Output	 PNP NC / NO, programmable	 4...20 mA, linear
Supply voltage [V]	24 DC ±10%	
Current consumption [mA]	100	
Switching current [mA]	200 (20 °C)	
Load R _L [Ω]	200...500	
Ambient temperature [°C]	0...+60	
Medium temperature [°C]	5...+60	
Medium conductivity [μS/cm]	≥ 10 (water: ≥ 15)	≥ 20 (water: ≥ 30)
Reaction time [s]	0.5...8	
Programmable functions	switching point, hysteresis, switching output, time on/off delay, analog range, averaging, access code	
Compressive strength [bar]	10	
Material	housing: PBT sensor: PVDF / AISI 316 Ti	
Protection [EN 60529]	IP 65	
Connection	M12 connector	
*Note: Reference conditions according to EN 29104		
Accessories	mounting plate, connecting cable type SLG, SLW (page 1.99), adapter G1/4 (page 1.103)	

Magnetic flowmeter • Digital display

Series SDI 850 - Magnetic flowmeter



Measurement error <2%

Programmable

Analog and PNP output

Impulse output

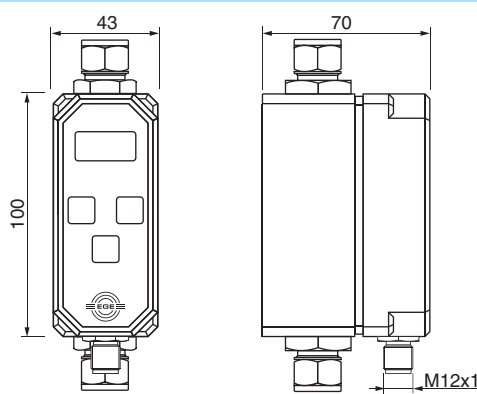
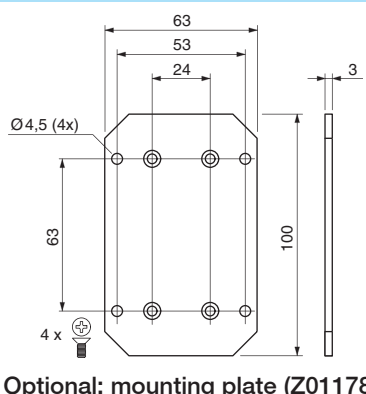
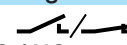

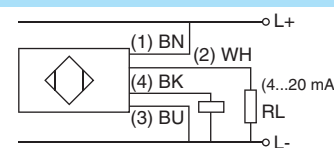
Design	SDI... GAPP	
Dimensions		 <p>Optional: mounting plate (Z01178)</p>
Working range [l/min]	0...40	0,2...80
Measurement error	0...5.0 l/min ≤0.1 l/min 5...40 l/min ≤2% of measurement value*	0...10.0 l/min ≤0.2 l/min 10.1...80 l/min ≤2% of measurement value*
ID-No.	P11322	P11323
Type	SDI 853/1 GAPP	SDI 853/2 GAPP
Pulse output ¹	•	•
Outer diameter pipe [mm]	10	15
Pipe connection	tube fittings for steel tubes accord. to DIN 2391 / ISO 3304	
Output	 PNP NC / NO, programmable	 4...20 mA, linear
Supply voltage [V]	24 DC ±10%	
Current consumption [mA]	100	
Switching current [mA]	200	
Load R _L [Ω]	200...500	
Ambient temperature [°C]	0...+60	
Medium temperature [°C]	5...+60	
Medium conductivity [μS/cm]	≥10 (water: ≥15)	≥20 (water: ≥30)
Reaction time [s]	0.5...8	
Programmable functions	switching point, hysteresis, switching output, time on/off delay, analog range, impulse, averaging, access code	
Compressive strength [bar]	10	
Material	housing: PBT sensor: PVDF / AISI 316 Ti	
Protection [EN 60529]	IP 65	
Connection	M12 connector	
*Note: Reference conditions according to EN 29104	¹ Impulses can be set to 1, 5, 10 and 50 ml/pulse.	
Accessories	mounting plate, connecting cable type SLG, SLW (page 1.99), adapter G1/4 (page 1.103)	

Probe • Screw-in mounting

Series **LTZ 400**

G1/2 thread

Stainless steel

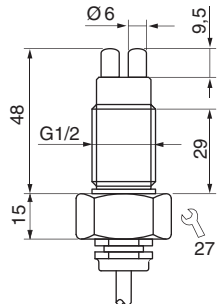
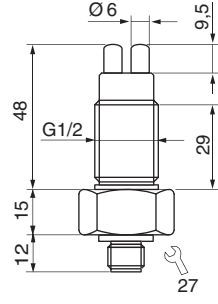

Design	G1/2	G1/2
Dimensions		
Detection range [m/s]	0.5...30	0.5...30
Sensor length [mm]	48	48
ID-No.	P11100	P11101
Type	LTZ 421 K-A2	LTZ 421 S-A2
Medium temperature [°C]	-20...+80	
Temperature gradient [K/min]	20	
Start-up time typ. [s]	10...90	
Reaction time typ. [s]	2...30	
Switching-off time [s]	5...30	
Compressive strength [bar]	30	
Sensor material	AISI 303 • different materials on request	
Protection [EN 60529]	IP 68	IP 67
Connection	2 m PVC-cable 4x0.25 mm ²	M12 connector

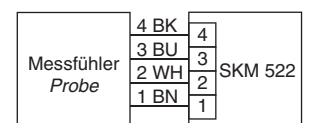
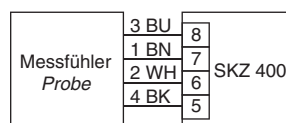
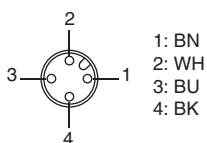

Amplifiers required: SKZ..., SKM..., page 1.71 - 1.75

Accessories

connecting cable type SLG 4-2, SLG 4-5, SLW 4-2, SLW 4-5, see page 1.99

Compact models

Series LN 500 / LG 500

DC 24 V



PNP output

Analog output

LED display

Detection range 0.5...15 m/s

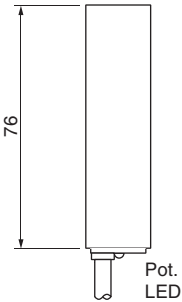
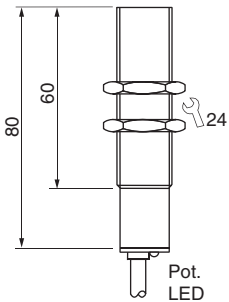

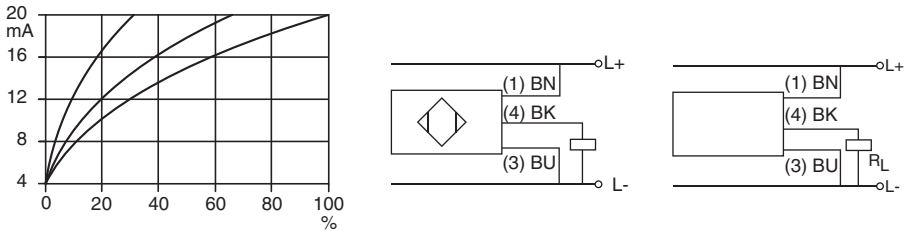
Design	Ø20 mm		M18x1	
Dimensions				
Detection range [m/s]	0.5...15		0.5...15	
Output	PNP	4...20 mA	PNP	4...20 mA
ID-No.	P11096*	P11097*	P11237*	P11240*
Type	LN 520 GSP	LN 520 GA	LG 518 GSP	LG 518 GA
Supply voltage [V]	24 DC ±20%		24 DC ±20%	
Current consumption [mA]	70		70	
Switching current [mA]	200		200	
Load R _L [Ω]	-		200...500	
Ambient temperature [°C]	-20...+70			
Temperature gradient [K/min]	200			
Start-up time [s]	20...40			
Reaction time typ. [s]	2	3	2	3
Housing material	PBT	PBT	PBT / Br-Ni	PBT / Br-Ni
Display flow	LED			
Protection [EN 60529]	IP 67			
Connection	2 m PVC-cable 3x0.5 mm ²			
*  US LISTED E304328				
Accessories	flange Ø20 mm (Z01106), see page 1.102			

Compact models • Screw-in mounting



Series LNZ 450

DC 24 V

Analog output

G1/2 thread

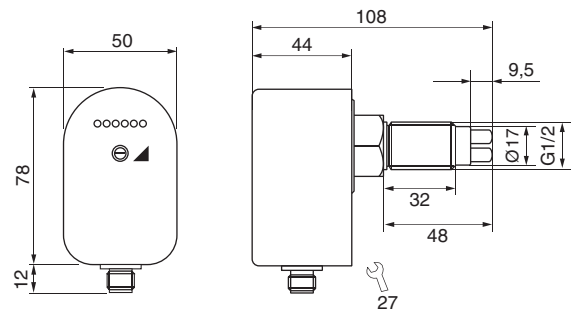

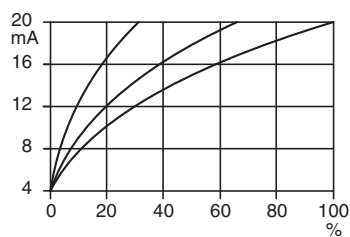
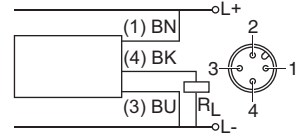
Design	G1/2	
Dimensions		
Detection range [m/s]	0.5...30	
Output	 4...20 mA	
ID-No.	P11110*	P11111*
Type	LNZ 450 GA-K	LNZ 450 GA-S
Supply voltage [V]	24 DC ±15 %	
Current consumption [mA]	80	
Current output [mA]	4...20	
Load R _L [Ω]	200...500	
Ambient temperature [°C]	-20...+70	
Medium temperature [°C]	-20...+80	
Temperature gradient [K/min]	20	
Start-up time typ. [s]	20...90	
Reaction time typ. [s]	4...30	
Compressive strength [bar]	30	
Sensor material	AISI 303	
Display flow	LED-array	
Protection [EN 60529]	IP 67	
Connection	2 m PVC-cable 3x0.5 mm ²	M12 connector
*  US LISTED E304328	 	
Accessories	connecting cable type SLG 3-2, SLG 3-5, SLW 3-2, SLW 3-5, see page 1.99	

Air Flow Sensors



Compact models • Screw-in mounting

Series LNZ 450

AC 230 V • AC 115 V

DC 24 V

Relay output

G1/2 thread



Design	G1/2		G1/2	
Dimensions				
Detection range [m/s]	0.5...30		0.5...30	0.5...30
Output	 Relay		 Relay	 Relay
ID-No.	P11102		P11103	
Type	LNZ 450 WR1-K		LNZ 450 WR2-K	
Supply voltage [V]	115 AC ±15%		230 AC ±15%	
Current consumption [mA]	60		80	
Switching voltage [V]	250 AC / 60 DC		250 AC / 60 DC	30 AC / 36 DC
Switching current [A]	4 AC / 4 DC		4 AC / 4 DC	1 AC / 1 DC
Switching power max.	1000 VA / 60 W		1000 VA / 60 W	
Ambient temperature [°C]	-20...+70		-20...+70	
Medium temperature [°C]	-20...+80		-20...+80	
Temperature gradient [K/min]	20		20	
Start-up time typ. [s]	10...90		10...90	
Reaction time typ. [s]	2...30		2...30	
Compressive strength [bar]	30		30	
Sensor material	AISI 303		AISI 303	
Housing material	PBT		PBT	
Display flow	LED-array		LED-array	
Protection [EN 60529]	IP 67		IP 67	
Connection	2 m PVC-cable 5x0.5 mm ²		2 m PVC-cable 5x0.5 mm ²	M12 connector

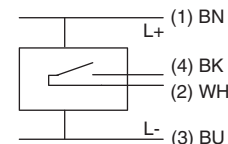
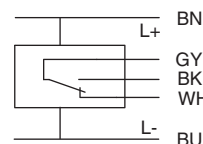
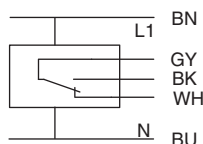
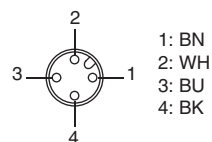

Accessories connecting cable type SLG 4-2, SLG 4-5, SLW 4-2, SLW 4-5, see page 1.99

Compact models • Sleeve mounting

Series LN 450

AC 230 V • AC 115 V

DC 24 V

Relay output

Suitable for assembly
thread pieces



Design	G1		G1	
Dimensions				
Detection range [m/s]	0.5...30		0.5...30	0.5...30
Output	Relay		Relay	Relay
ID-No.	P11106	P11107	P11108	P11109
Type	LN 450 WR1-K	LN 450 WR2-K	LN 450 GR-K	LN 450 GR-S
Supply voltage [V]	115 AC ±15%	230 AC ±15%	24 DC ±20%	
Current consumption [mA]	60	30	80	
Switching voltage [V]	250 AC / 60 DC		250 AC / 60 DC	30 AC / 36 DC
Switching current [A]	4 AC / 4 DC		4 AC / 4 DC	1 AC / 1 DC
Switching power max.	1000 VA / 60 W		1000 VA / 60 W	500 VA / 60 W
Ambient temperature [°C]	-20...+70		-20...+70	
Medium temperature [°C]	-20...+80		-20...+80	
Temperature gradient [K/min]	20		20	
Start-up time typ. [s]	10...90		10...90	
Reaction time typ. [s]	2...30		2...30	
Compressive strength [bar]	3		3	
Sensor material	AISI 303 / Delrin		AISI 303 / Delrin	
Hosuing material	PBT		PBT	
Display flow	LED-array		LED-array	
Protection [EN 60529]	IP 67		IP 67	
Connection	2 m PVC-cable 5x0.5 mm ²		2 m PVC-cable 5x0.5 mm ²	M12 connector
Accessories	thread sleeve A 50..., see page 1.102			

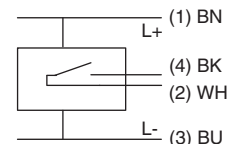
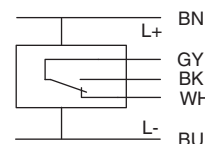
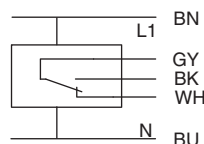
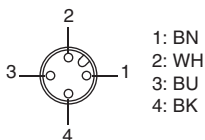

Compact models • Sleeve mounting



Series LN 450

DC 24 V

Analog output

Suitable for assembly
thread pieces

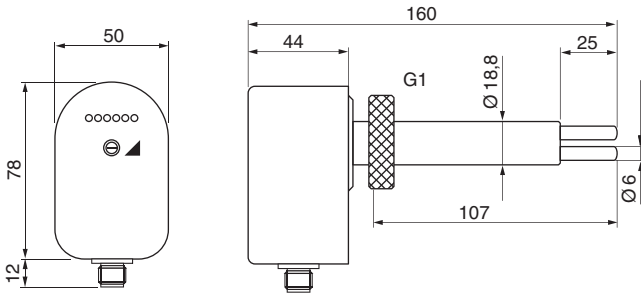

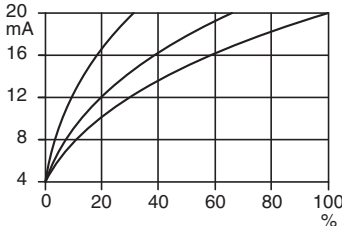
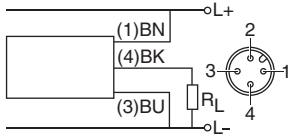
Design	G1	
Dimensions		
Detection range [m/s]	0.5...30	
Output	 4...20 mA	
ID-No.	P11098*	P11099*
Type	LN 450 GA-K	LN 450 GA-S
Supply voltage [V]	24 DC ±15%	
Current consumption [mA]	80	
Current output [mA]	4...20	
Load RL [Ω]	200...500	
Ambient temperature [°C]	-20...+70	
Medium temperature [°C]	-20...+80	
Temperature gradient [K/min]	20	
Start-up time typ. [s]	20...90	
Reaction time typ. [s]	4...30	
Compressive strength [bar]	3	
Sensor material	AISI 303 / Delrin	
Display flow	LED-array	
Protection [EN 60529]	IP 67	
Connection	2 m PVC-cable, 3x0.5 mm ²	M12 connector
*  US LISTED E304328	 	
Accessories	thread sleeve A 50..., see page 1.102	

Inline-Compact

Series LDN 500

PNP output

Relay output

Analog output

G1/4 thread • Ø9 mm

Compressed-air monitoring



Design	G1/4 • Ø9 mm		
Dimensions			
Detection range [m/s]	0.2...60		
Working range [m/s]	0.5...40		
Inner diameter d [mm]	9		
Output			
ID-No.	P11299 *	P11300	P11301 *
Type	LDN 510 GSP	LDN 510 GR	LDN 510 GA
Supply voltage [V]	24 DC ±10%	24 DC ±10%	24 DC ±10%
Current consumption [mA]	< 50	< 50	< 50
Switching current [mA]	200 (20 °C)	1000	-
Switching voltage [V]	-	30 AC / 36 DC	-
Load R _L [Ω]	-	-	200...500
Ambient temperature [°C]	-	0...+60	-
Medium temperature [°C]	-	-20...+80	-
Temperature gradient [K/min]	-	20	-
Start-up time typ. [s]	-	10...30	-
Reaction time typ. [s]	-	1...20	-
Compressive strength [bar]	-	20	-
Display flow	LED-array		
Material	housing: PBT sensor: AISI 316 Ti		
Protection [EN 60529]	IP 67		
Connection	M12 connector		
* US LISTED E304328			
Accessories	connecting cable type SLG, SLW, SBG, SBW, see page 1.99		

Air flow sensor • with IO-Link

Series LDN 1000 GAPL

Mass flow measurement

Configurable via IO-Link

Compressed air measurement

Monitoring of temperature



Use
 IO-Link
 Universal • Smart • Easy

Design	G1/4
Dimensions	
Detection ranges air	
Flow ¹ [Nm ³ /h] [NI/min]	0.04...15.00 / 0.5...250.0
Temperature [°C]	0.0...60.0
Output	 PNP/NPN-NO/NC 200 mA (20 °C) / 4...20 mA / pulse output PNP/NPN-NO / IO-Link
ID-No.	P11373
Type	LDN 1009 GAPL
Process data	
Consumption [Nm ³ x 0.001]	0...999999 x 10 ⁶
Flow [Nm ³ /h x 0.01]	0...1500
Temperature [°C x 0.1]	0...600
Measurement error	flow: ±(4 % of measurement value + 0.5 % of end value) / temperature: ±2 °C
Supply voltage [V]	18...30 DC
Current consumption [mA]	≤70
Ambient temperature [°C]	0...+60
Medium temperature [°C]	0...+60
Start-up time / Reaction time [s]	4...12 / <0.3
Adjustable parameters	output functions, switching points, units, range, average value, MIN/MAX value
IO-Link-Specifications	revision 1.1, baud rate COM 2, min. cycle time 5 ms, process data 8 Byte
Compressive strength [bar]	16
Material	housing: PBT-GF30 sensor: aluminium, stainless steel, ceramic, PA
Protection [EN 60529]	IP 54
Connection	M12 connector
¹ Reference 1013 mbar / 20 °C	 2 (WH): 4...20 mA / PNP/NPN output / Input 4 (BK): PNP/NPN output / pulse output / IO-Link RL: 200...500 Ohm figure: PNP output
Accessories	Mounting plate 72x63x3 (Z01217), IO-Link/USB master set (Z01216), page 1.98

Air flow sensor • with IO-Link

Series LDV 1000 GAPL

Venturi principle

Monitoring of pressure and temperature

Consumption measurement

Configurable via IO-Link



Design	G1	G1 1/2
Dimensions		
Detection ranges air		
Flow ¹ [Nm ³ /h] [NI/min]	3...420 / 50...7000 (at 7 bar abs)	5...750 / 80...12500 (at 6 bar abs)
Temp. / Pressure [°C] / [bar abs]	0.0...60.0 / 0.00...14.00	0.0...60.0 / 0.00...14.00
Output		
ID-No.	P11382	P11383
Type	LDV 1025 GAPL	LDV 1040 GAPL
Process data		
Consumption [Nm ³ x 0.001]	0...999999 x 10 ⁶	0...999999 x 10 ⁶
Flow [Nm ³ /h x 0.1]	0...4200	0...7500
Pressure [bar x 0.1]	0...140	0...140
Temperature [°C x 0.1]	0...600	0...600
Measurement error	flow: ± (5% of measurement value + 0,5% of end value) / temperature: ± 2 °C	
Supply voltage [V]	18...30 DC	
Current consumption [mA]	≤ 105	
Ambient temperature [°C]	0...+60	
Medium temperature [°C]	0...+60	
Start-up time / Reaction time [s]	4...12 / < 0.3	
Adjustable parameters	output functions, switching points, units, range, average value, MIN/MAX value	
IO-Link-Specifications	revision 1.1, baud rate COM 2, min. cycle time 6 ms, process data 10 Byte	
Compressive strength [bar]	11 (burst pressure 16)	
Material	housing: aluminium, PBT-GF30 sensor: aluminium, stainless steel, ceramic, epoxy	
Protection [EN 60529]	IP 54	
Connection	M12 connector	
¹ Reference 1013 mbar / 20 °C		
Accessories	IO-Link/USB master set (Z01216)	

Air flow sensor • with IO-Link

Series LDS 1000 GAPL

Dynamic pressure principle

Plug-in sensor for big pipes



Consumption measurement

Configurable via IO-Link

Use

 Universal · Smart · Easy

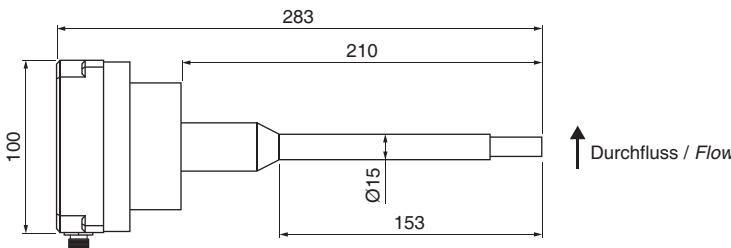

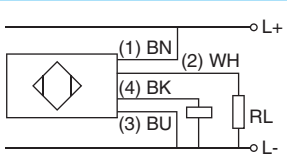

Design	Ø 15
Dimensions	
Detection ranges air	depending on inner pipe diameter $d=38...200$ [mm]
Flow [Nm ³ /h]	example $d=38$: 14...1400, $d=50$: 27...2650, $d=100$: 121...12150, $d=200$: 515...51500
Temp. / Pressure [°C] / [bar abs]	0...60 / 0.00...14.00
Output	 PNP/NPN-NO/NC 200 mA (20 °C) / 4...20 mA / pulse output PNP/NPN-NO / IO-Link
ID-No.	P11383
Type	LDS 1000 GAPL
Process data	
Consumption [Nm ³ x 0.001]	0...999999 x 10 ⁶
Flow [% x 0.01]	0...10000
Pressure [bar x 0.1]	0...140
Temperature [°C x 0.1]	0...600
Measurement error	flow: ± (8 % of measurement value + 0.5 % of end value) / temperature: ± 2 °C
Supply voltage [V]	18...30 DC
Current consumption [mA]	≤ 105
Ambient temperature [°C]	0...+60
Medium temperature [°C]	0...+60
Start-up time / Reaction time [s]	4...12 / < 0.3
Adjustable parameters	output functions, switching points, units, range, average value, MIN/MAX value
IO-Link-Specifications	revision 1.1, baud rate COM 2, min. cycle time 6 ms, process data 10 Byte
Compressive strength [bar]	11 (burst pressure 16)
Material	housing: aluminium, PBT-GF30 sensor: aluminium, stainless steel, ceramic, epoxy
Protection [EN 60529]	IP 54
Connection	M12 connector
¹ Reference 1013 mbar / 20 °C	
Note: Screw-in union G1/2 (zinc-coated steel) is part of delivery	 <p>figure: PNP output</p> <p>2 (WH): 4...20 mA / PNP/NPN output / Input 4 (BK): PNP/NPN output / pulse output / IO-Link RL: 200...500 Ohm</p>
Accessories	IO-Link/USB master set (Z01216), screw-in union G1/2-Ø 15 (Z01290), weld-on union Ø 30 (Z01291)

Amplifiers DC • Relay output

Series SKM 420

DC 24 V
Relay output
LED display

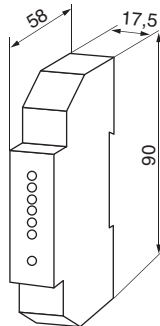

Design	SKM 420 GR	SKM 421 GR (air flow)
Dimensions		
ID-No.	P10530	P11067
Type	SKM 420 GR	SKM 421 GR (air flow)
Output	 Relay	 Relay
Supply voltage [V]	24 DC ±20%	
Output	Relay / NO	
Switching voltage max. [V]	230 AC / 30 DC	
Switching current max. [A]	1 AC / 1 DC	
Switching power max.	125 VA	
Load R_L [Ω]	-	
Ambient temperature [$^{\circ}\text{C}$]	-20...+60	
Protection [EN 60529]	terminal: IP 20 / housing: IP 40	
Amplifier for probe	STA..., STB..., STC..., STD..., STK..., ST... (none Ex)	LTZ...

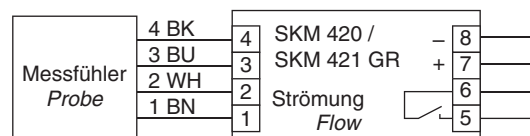

Amplifiers DC • PNP output

Series SKM 420

DC 24 V
PNP output
Analog output
LED display



Design	SKM 420 GSP	SKM 421 GSP (air flow)	SKM 420 GA
Dimensions			
ID-No.	P11392	P11393	P10820
Type	SKM 420 GSP	SKM 421 GSP	SKM 420 GA
Output			
Supply voltage [V]	24 DC ±20%		24 DC ±10%
Switching current max. [mA]	400 (20 °C)		-
Load RL [Ω]	-		50...500
Ambient temperature [°C]	-20...+60		-20...+60
Protection [EN 60529]	terminal: IP 20 / housing: IP 40		terminal: IP 20 / housing: IP 40
Amplifier for probe	STA..., STB..., STC..., STD..., STK..., ST... (none Ex)	LTZ...	ST... / LTZ... (none Ex)

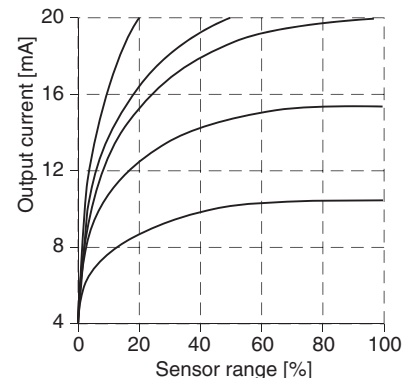
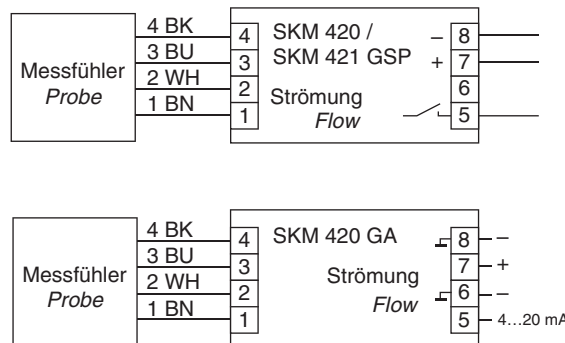
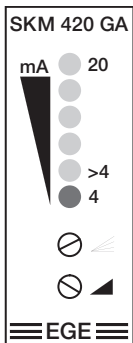

Amplifiers DC • Relay output

Series SKM 520

DC 24 V



Relais output

LED display

ST 521...

SD 5...

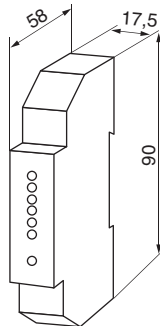

Design	SKM 520 GR
Dimensions	
ID-No.	P11391
Type	SKM 520 GR
Output	 Relay
Supply voltage [V]	24 DC ±20%
Output	Relay / NO
Switching voltage max. [V]	230 AC / 30 DC
Switching current max. [A]	1 AC / 1 DC
Switching power max.	125 VA
Load R_L [Ω]	-
Ambient temperature [°C]	-20...+60
Protection [EN 60529]	terminal: IP 20 / housing: IP 40
Amplifier for probe	ST 521..., SD 5...

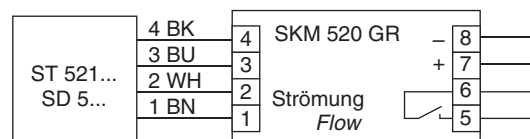

Amplifiers AC/DC • Automatic adjustment

Series SKM 522

AC 85 V...AC 260 V



DC 24 V

Relay output

Programming with push-buttons

Automatic adjustment

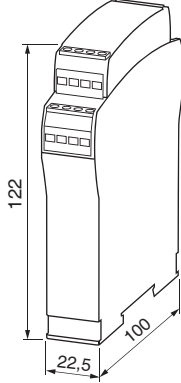

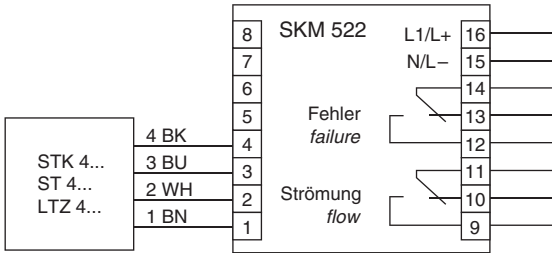
Design	SKM 522 WR	SKM 522 GR
Dimensions		
ID-No.	P11336	P11337
Type	SKM 522 WR	SKM 522 GR
Output	 Relay	 Relay
Supply voltage [V]	85 AC...260 AC	24 DC ±20%
Turn off delay [s]	0...20 programmable	
Output	2x relay / change-over	
Switching voltage max. [V]	250 AC / 60 DC	
Switching current max. [A]	4 AC / 4 DC	
Switching power max.	1000 VA / 60 W	
Ambient temperature	-20...+60	
Additional functions	cable break monitoring, turn off delay, supply voltage monitoring	
Protection [EN 60529]	terminal: IP 20 / housing: IP 40	
Connection	terminal screws	
Amplifier for probe	STA..., STB..., STC..., STD..., STK..., ST... (none Ex), LTZ...	
		

Amplifiers AC/DC • Potentiometer

Series SKZ

AC 230 V • AC 115 V

DC 24 V





Relay output

LED display

Temperature control

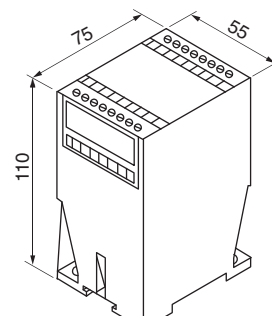
Turn off delay



Design	SKZ 400 WR	SKZ 400 WR-115	SKZ 400 GR
Dimensions			
ID-No.	P10501	P10502	P10503
Type	SKZ 400 WR	SKZ 400 WR -115	SKZ 400 GR
Output	 Relay	 Relay	 Relay
Supply voltage [V]	230 AC +10/-10%	115 AC +10/-10%	24 DC ±20%
Temperature [°C]		-20...+100 adjustable	
Turn off delay [s]		0...25 adjustable	
Output		2x relay / change-over	
Switching voltage max. [V]		250 AC / 60 DC	
Switching current max. [A]		4 AC / 4 DC	
Switching power max.		1000 VA / 60 W	
Ambient temperature [°C]		-20...+60	
Protection [EN 60529]		terminal: IP 20 / housing: IP 40	
Connection		terminal screws	

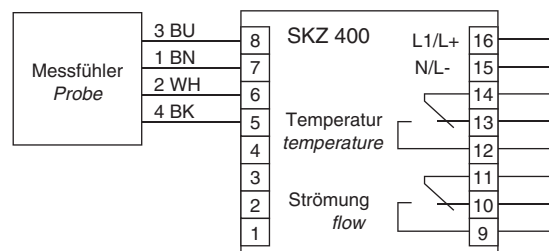

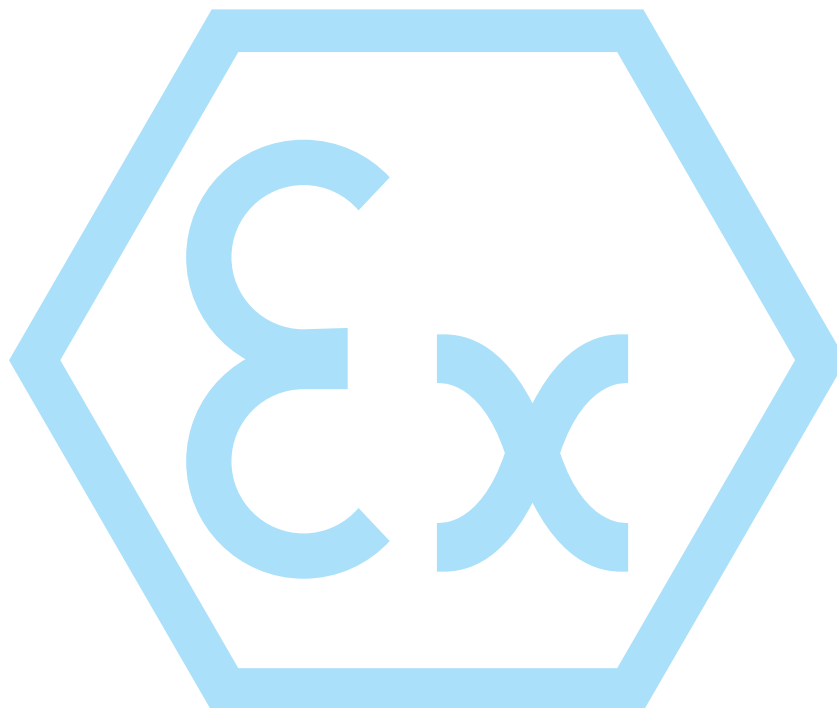

Probes
Compact models
Amplifiers

Ex - Probe • Device category 1G/2G and 1D

Series STS

Ex - Device category 1G/2G
Installation in partition wall
Zone 0 / Zone 1 (gas)

Ex - Device category 1D
Installation in Zone 20 (dust)



Design	G1/4	G1/2	G1/2	NPT1/2	G3/4
Dimensions					
Detection range [cm/s]	water 1...100 / oil 3...200				
Sensor length [mm]	25	31	48	40	48
Connection	plug	plug	plug	plug	plug
ID-No.	P11164	P11165	P11166	P11167	P11169
Type	STS 101 S	STS 102 S	STS 103 S	STS 104 S	STS 106 S
Ex area of use	Gas: Partition wall Zone 0 / Zone 1 / Dust: Zone 20				
Certificate No.	TÜV 98 ATEX 1298 X				
Ex marking	Gas: Ex II 1/2 G Ex ia IIC T6 Ga/Gb Dust: Ex II 1 D Ex ia IIIC T100 °C Da				
Ambient temperature and medium temperature [°C]	Gas: T6: -20 ≤ Ta ≤ +40 T5: -20 ≤ Ta ≤ +55 T4: -20 ≤ Ta ≤ +60 T3: -20 ≤ Ta ≤ +60 Dust: -20 ≤ Ta ≤ +60				
Maximum values	Ui = 13.65 V / li = 200 mA / Pi = 0.69 W / Ci = 0.27 nF / Li = 1.30 µH				
Start-up time typ. [s]	8 (2...18)				
Reaction time typ. [s]	2 (1...13)				
Compressive strength [bar]	60				
Housing material	AISI 316 Ti • different materials on request				
Protection [EN 60529]	IP 67				
Connection	M12 connector				
Note:	(probes with cable length > 2 m are available on request) for the connection to amplifier SZA..., page 1.94				

- Probe • Device category 1G/2G and 1D

Series STS

-Device category 1G/2G
Installation in partition wall
Zone 0 / Zone 1 (gas)

-Device category 1D
Installation in Zone 20 (dust)



Design	G1/4	G1/2	G1/2	NPT1/2	G3/4
Dimensions					
Detection range [cm/s]	water 1...100 / oil 3...200				
Sensor length [mm]	25	31	48	40	48
Connection	fixed cable	fixed cable	fixed cable	fixed cable	fixed cable
ID-No.	P11140	P11141	P11142	P11143	P11168
Type	STS 101 K	STS 102 K	STS 103 K	STS 104 K	STS 106 K
Ex area of use	Gas: Partition wall Zone 0 / Zone 1 / Dust: Zone 20				
Certificate No.	TÜV 98 ATEX 1298 X				
Ex marking	Gas: II 1/2 G Ex ia IIC T6 Ga/Gb Dust: II 1 D Ex ia IIIC T100 °C Da				
Ambient temperature and medium temperature [°C]	Gas: T6: $-20 \leq T_a \leq +40$ T5: $-20 \leq T_a \leq +55$ T4: $-20 \leq T_a \leq +60$ T3: $-20 \leq T_a \leq +60$ Dust: $-20 \leq T_a \leq +60$				
Maximum values	$U_i = 13.65 \text{ V}$ / $I_i = 200 \text{ mA}$ / $P_i = 0.69 \text{ W}$ / $C_i = 0.27 \text{ nF}$ / $L_i = 1.30 \text{ }\mu\text{H}$				
Start-up time typ. [s]	8 (2...18)				
Reaction time typ. [s]	2 (1...13)				
Compressive strength [bar]	60				
Housing material	AISI 316 Ti • different materials on request				
Protection [EN 60529]	IP 67				
Connection	2 m PUR-cable 4x0.25 mm ²				
Note:	(probes with cable length > 2 m are available on request) for the connection to amplifier SZA..., page 1.94				

Ex - Probe • Device category 2G and 2D

Series ST

Ex - Device category 2G
Installation in Zone 1 (gas)

Ex - Device category 2D
Installation in Zone 21 (dust)



Design	G1/4	G1/2	G1/2	NPT1/2	G3/4
Dimensions					
Detection range [cm/s]	water 1...100 / oil 3...200				
Sensor length [mm]	25	31	48	40	48
Connection	plug	plug	plug	plug	plug
ID-No.	P11170	P11171	P11172	P11173	P11175
Type	ST 101 S	ST 102 S	ST 103 S	ST 104 S	ST 106 S
Ex area of use	Gas: Zone 1 / Dust: Zone 21				
Certificate No.	TÜV 97 ATEX 1218				
Ex marking	Gas: Ex II 2 G Ex ib IIC T6 Gb Dust: Ex II 2 D Ex ib IIIC T125 °C Db				
Ambient temperature and medium temperature [°C]	Gas: T6: -20 ≤ Ta ≤ +40 T5: -20 ≤ Ta ≤ +55 T4: -20 ≤ Ta ≤ +85 T3: -20 ≤ Ta ≤ +85 Dust: -20 ≤ Ta ≤ +85				
Maximum values	Ui = 13.65 V / li = 200 mA / Pi = 0.69 W / Ci = 0.27 nF / Li = 1.30 µH				
Start-up time typ. [s]	8 (2...18)				
Reaction time typ. [s]	2 (1...13)				
Compressive strength [bar]	60				
Housing material	AISI 316 Ti • different materials on request				
Protection [EN 60529]	IP 67				
Connection	M12 connector				

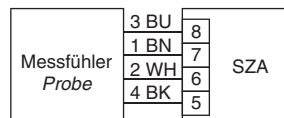
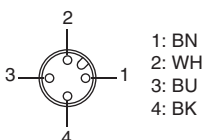

(probes with cable length > 2 m are available on request)

Note: for the connection to amplifier SZA..., page 1.94

- Probe • Device category 2G and 2D

Series ST

-Device category 2G
Installation in Zone 1 (gas)

-Device category 2D
Installation in Zone 21 (dust)



Design	G1/4	G1/2	G1/2	NPT1/2	G3/4
Dimensions					
Detection range [cm/s]	water 1...100 / oil 3...200				
Sensor length [mm]	25	31	48	40	48
Connection	fixed cable	fixed cable	fixed cable	fixed cable	fixed cable
ID-No.	P11144	P11145	P11146	P11147	P11174
Type	ST 101 K	ST 102 K	ST 103 K	ST 104 K	ST 106 K
Ex area of use	Gas: Zone 1 / Dust: Zone 21				
Certificate No.	TÜV 97 ATEX 1218				
Ex marking	Gas: II 2 G Ex ib IIC T6 Gb Dust: II 2 D Ex ib IIIC T125 °C Db				
Ambient temperature [°C] and medium temperature	Gas: T6: -20 ≤ Ta ≤ +40 T5: -20 ≤ Ta ≤ +55 T4: -20 ≤ Ta ≤ +85 T3: -20 ≤ Ta ≤ +85 Dust: -20 ≤ Ta ≤ +85				
Maximum values	Ui = 13.65 V / li = 200 mA / Pi = 0.69 W / Ci = 0.27 nF / Li = 1.30 µH				
Start-up time typ. [s]	8 (2...18)				
Reaction time typ. [s]	2 (1...13)				
Compressive strength [bar]	60				
Housing material	AISI 316 Ti • different materials on request				
Protection [EN 60529]	IP 67				
Connection	2 m PUR-cable 4x0.25 mm ²				

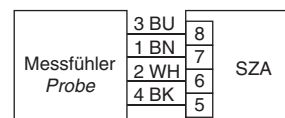

(probes with cable length > 2 m are available on request)

Note: for the connection to amplifier SZA..., page 1.94

Ex - Probe • Device category 2G and 2D

Series ST

Ex - Device category 2G
Installation in Zone 1 (gas)

Ex - Device category 2D
Installation in Zone 21 (dust)

Extended temperature range
up to 120 °C



Design	G1/4	G1/2	G1/2	NPT1/2	G3/4
Dimensions					
Detection range [cm/s]	water 1...100 / oil 3...200				
Sensor length [mm]	25	31	48	40	48
Connection	fixed cable	fixed cable	fixed cable	fixed cable	fixed cable
ID-No.	P11176	P11178	P11180	P11182	P11184
Type	ST 101 KH	ST 102 KH	ST 103 KH	ST 104 KH	ST 106 KH
Ex area of use	Gas: Zone 1 / Dust: Zone 21				
Certificate No.	TÜV 97 ATEX 1218				
Ex marking	Gas: Ex II 2 G Ex ib IIC T6 Gb Dust: Ex II 2 D Ex ib IIIC T125 °C Db				
Ambient temperature and medium temperature [°C]	Gas: T6: +10 ≤ Ta ≤ +40 T5: +10 ≤ Ta ≤ +55 T4: +10 ≤ Ta ≤ +90 T3: +10 ≤ Ta ≤ +120 Dust: -20 ≤ Ta ≤ +85				
Maximum values	Ui = 13.65 V / li = 200 mA / Pi = 0.69 W / Ci = 0.27 nF / Li = 1.30 μH				
Start-up time typ. [s]	8 (2...18)				
Reaction time typ. [s]	2 (1...13)				
Compressive strength [bar]	60				
Housing material	AISI 316 Ti • different materials on request				
Protection [EN 60529]	IP 67				
Connection	2 m FEP-cable 4x0.25 mm ²				



(probes with cable length > 2 m are available on request)

Note: for the connection to amplifier SZA..., page 1.94

- Probe • Device category 1G/2G and 1D

Series STS

-Device category 1G/2G
Installation in partition wall
Zone 0 / Zone 1 (gas)

-Device category 1D
Installation in Zone 20 (dust)



Design	G1/2				
Dimensions					
Detection range [cm/s]	water 1...100 / oil 3...200				
Sensor length L [mm]	48	48	80	110	140
Connection	fixed cable	plug	fixed cable	fixed cable	fixed cable
ID-No.	P11186	P11187	P11188	P11189	P11190
Type	STS 110 K	STS 110 S	STS 110 K-L80	STS 110 K-L110	STS 110 K-L140
Ex area of use	Gas: Partition wall Zone 0 / Zone 1 / Dust: Zone 20				
Certificate No.	TÜV 98 ATEX 1298 X				
Ex marking	Gas: II 1/2 G Ex ia IIC T6 Ga/Gb Dust: II 1 D Ex ia IIIC T100 °C Da				
Ambient temperature and medium temperature [°C]	Gas: T6: $-20 \leq T_a \leq +40$ T5: $-20 \leq T_a \leq +55$ T4: $-20 \leq T_a \leq +60$ T3: $-20 \leq T_a \leq +60$ Dust: $-20 \leq T_a \leq +60$				
Maximum values	$U_i = 13.65 \text{ V} / I_i = 200 \text{ mA} / P_i = 0.69 \text{ W} / C_i = 0.27 \text{ nF} / L_i = 1.30 \text{ }\mu\text{H}$				
Start-up time typ. [s]	8 (2...18)				
Reaction time typ. [s]	2 (1...13)				
Compressive strength [bar]	60				
Housing material	AISI 316 Ti • different materials on request				
Protection [EN 60529]	cable ...K: IP 67 / plug ...S: IP 67				
Connection	...K: 2 m PUR-cable 4x0.25 mm ² ...S: M12 connector				
	1: BN 2: WH 3: BU 4: BK	Messfühler Probe			
Note:	for the connection to amplifier SZA..., page 1.94				

Ex - Probe • Device category 2G and 2D

Series ST

Ex - Device category 2G
Installation in Zone 1 (gas)

Ex - Device category 2D
Installation in Zone 21 (dust)



Design	G1/2				
Dimensions					
Detection range [cm/s]	water 1...100 / oil 3...200				
Sensor length L [mm]	48	48	80	110	140
Connection	fixed cable	plug	fixed cable	fixed cable	fixed cable
ID-No.	P11192	P11193	P11194	P11195	P11196
Type	ST 110 K	ST 110 S	ST 110 K-L80	ST 110 K-L110	ST 110 K-L140
Ex area of use	Gas: Zone 1 / Dust: Zone 21				
Certificate No.	TÜV 97 ATEX 1218				
Ex marking	Gas: Ex II 2 G Ex ib IIC T6 Gb Dust: Ex II 2 D Ex ib IIIC T125 °C Db				
Ambient temperature and medium temperature [°C]	Gas: T6: -20 ≤ Ta ≤ +40 T5: -20 ≤ Ta ≤ +55 T4: -20 ≤ Ta ≤ +85 T3: -20 ≤ Ta ≤ +85 Dust: -20 ≤ Ta ≤ +85				
Maximum values	Ui = 13.65 V / li = 200 mA / Pi = 0.69 W / Ci = 0.27 nF / Li = 1.30 µH				
Start-up time typ. [s]	8 (2...18)				
Reaction time typ. [s]	2 (1...13)				
Compressive strength [bar]	60				
Housing material	AISI 316 Ti • different materials on request				
Protection [EN 60529]	cable ...K: IP 67 / plug ...S: IP 67				
Connection	...K: 2 m PUR-cable 4x0.25 mm ² / ...S: M12 connector				
	1: BN 2: WH 3: BU 4: BK	Messfühler Probe			8 7 6 5
		SZA			
Note:	(probes with cable length > 2 m are available on request) for the connection to amplifier SZA..., page 1.94				

- Probe • Device category 2G and 2D

Series ST

-Device category 2G
Installation in Zone 1 (gas)

-Device category 2D
Installation in Zone 21 (dust)

Extended temperature range
up to 120 °C



Design	G1/2			
Dimensions				
Detection range [cm/s]	water 1...100 / oil 3...200			
Sensor length L [mm]	48	80	110	140
Connection	fixed cable	fixed cable	fixed cable	fixed cable
ID-No.	P11198	P11200	P11201	P11202
Type	ST 110 KH	ST 110 KH-L80	ST 110 KH-L110	ST 110 KH-L140
Ex area of use	Gas: Zone 1 / Dust: Zone 21			
Certificate No.	TÜV 97 ATEX 1218			
Ex marking	Gas:	II 2 G Ex ib IIC T6 Gb		
	Dust:	II 2 D Ex ib IIIC T125 °C Db		
Ambient temperature and medium temperature [°C]	Gas:	T6: +10 ≤ Ta ≤ +40 T5: +10 ≤ Ta ≤ +55 T4: +10 ≤ Ta ≤ +90 T3: +10 ≤ Ta ≤ +120		
	Dust:	-20 ≤ Ta ≤ +85		
Maximum values	Ui = 13.65 V / li = 200 mA / Pi = 0.69 W / Ci = 0.27 nF / Li = 1.30 µH			
Start-up time typ. [s]	8 (2...18)			
Reaction time typ. [s]	2 (1...13)			
Compressive strength [bar]	60			
Housing material	AISI 316 Ti • different materials on request			
Protection [EN 60529]	IP 67			
Connection	2 m FEP-cable 4x0.25 mm ²			
	(probes with cable length > 2 m are available on request)			
Note:	for the connection to amplifier SZA..., page 1.94			

Ex - Probe • Device category 1G/2G and 1D

Series STS

Ex - Device category 1G/2G
Installation in partition wall
Zone 0 / Zone 1 (gas)

Ex - Device category 1D
Installation in Zone 20 (dust)

With welded standard flange

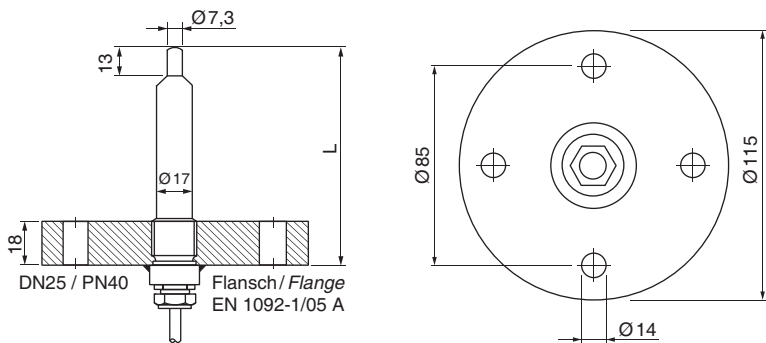

Design	DN25 / PN40 (EN 1092-1/05 A)		
Dimensions			
Detection range [cm/s]	water 1...100 / oil 3...200		
Sensor length L [mm]	80	110	140
Connection	fixed cable	fixed cable	fixed cable
ID-No.	P11191	P11148	P11149
Type	STS 111 K-L80	STS 111 K-L110	STS 111 K-L140
Ex area of use	Gas: Partition wall Zone 0 / Zone 1 / Dust: Zone 20		
Certificate No.	TÜV 98 ATEX 1298 X		
Ex marking	Gas:	Ex II 1/2 G Ex ia IIC T6 Ga/Gb	
	Dust:	Ex II 1 D Ex ia IIIC T100 °C Da	
Ambient temperature and medium temperature [°C]	Gas:	T6: -20 ≤ Ta ≤ +40 T5: -20 ≤ Ta ≤ +55 T4: -20 ≤ Ta ≤ +60 T3: -20 ≤ Ta ≤ +60	
	Dust:	-20 ≤ Ta ≤ +60	
Maximum values	Ui = 13.65 V / li = 200 mA / Pi = 0.69 W / Ci = 0.27 nF / Li = 1.30 µH		
Start-up time typ. [s]	8 (2...18)		
Reaction time typ. [s]	2 (1...13)		
Compressive strength [bar]	probe: 60 / flange: PN40		
Housing material	AISI 316 Ti • different materials on request		
Protection [EN 60529]	IP 67		
Connection	2 m PUR-cable 4x0.25 mm ²		

Messfühler Probe	3 BU	8	SZA
	1 BN	7	
	2 WH	6	
	4 BK	5	

(probes with cable length > 2 m and different flanges are available on request)

Note: for the connection to amplifier SZA..., page 1.94

Ex - Probe • Device category 2G and 2D

Series ST

Ex -Device category 2G
Installation in Zone 1 (gas)

Ex -Device category 2D
Installation in Zone 21 (dust)

With welded standard flange



Design	DN25 / PN40 (EN 1092-1/05 A)		
Dimensions			
Detection range [cm/s]	water 1...100 / oil 3...200		
Sensor length L [mm]	80	110	140
Connection	fixed cable	fixed cable	fixed cable
ID-No.	P11197	P11150	P11151
Type	ST 111 K-L80	ST 111 K-L110	ST 111 K-L140
Ex area of use	Gas: Zone 1 / Dust: Zone 21		
Certificate No.	TÜV 97 ATEX 1218		
Ex marking	Gas:	Ex II 2 G Ex ib IIC T6 Gb	
	Dust:	Ex II 2 D Ex ib IIIC T125 °C Db	
Ambient temperature and medium temperature [°C]	Gas:	T6: -20 ≤ Ta ≤ +40 T5: -20 ≤ Ta ≤ +55 T4: -20 ≤ Ta ≤ +85 T3: -20 ≤ Ta ≤ +85	
	Dust:	-20 ≤ Ta ≤ +85	
Maximum values	Ui = 13.65 V / li = 200 mA / Pi = 0.69 W / Ci = 0.27 nF / Li = 1.30 µH		
Start-up time typ. [s]	8 (2...18)		
Reaction time typ. [s]	2 (1...13)		
Compressive strength [bar]	60		
Housing material	AISI 316 Ti • different materials on request		
Protection [EN 60529]	IP 67		
Connection	2 m PUR-cable 4x0.25 mm ²		
Note:	(probes with cable length > 2 m and different flanges are available on request) for the connection to amplifier SZA..., page 1.94		

Ex - Probe • Device category 2G and 2D

Series ST

Ex - Device category 2G
Installation in Zone 1 (gas)

Ex - Device category 2D
Installation in Zone 21 (dust)

With welded standard flange
Extended temperature range
up to 120 °C

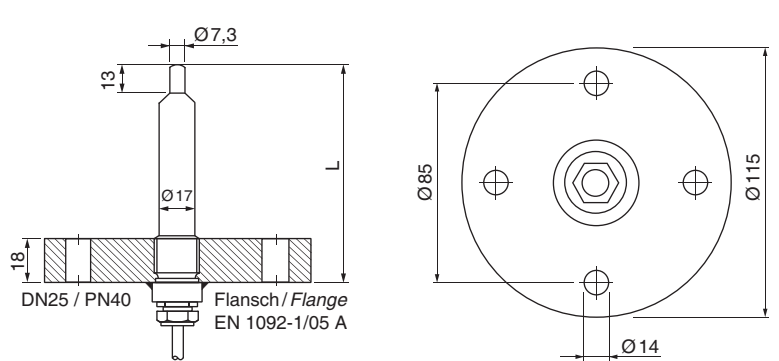

Design	DN25 / PN40 (EN 1092-1/05 A)		
Dimensions			
Detection range [cm/s]	water 1...100 / oil 3...200		
Sensor length L [mm]	80	110	140
Connection	fixed cable	fixed cable	fixed cable
ID-No.	P11203	P11204	P11205
Type	ST 111 KH-L80	ST 111 KH-L110	ST 111 KH-L140
Ex area of use	Gas: Zone 1 / Dust: Zone 21		
Certificate No.	TÜV 97 ATEX 1218		
Ex marking	Gas:	Ex II 2 G Ex ib IIC T6 Gb	
	Dust:	Ex II 2 D Ex ib IIIC T125 °C Db	
Ambient temperature and medium temperature [°C]	Gas:	T6: +10 ≤ Ta ≤ +40 T5: +10 ≤ Ta ≤ +55 T4: +10 ≤ Ta ≤ +90 T3: +10 ≤ Ta ≤ +120	
	Dust:	-20 ≤ Ta ≤ +85	
Maximum values	Ui = 13.65 V / li = 200 mA / Pi = 0.69 W / Ci = 0.27 nF / Li = 1.30 µH		
Start-up time typ. [s]	8 (2...18)		
Reaction time typ. [s]	2 (1...13)		
Compressive strength [bar]	60		
Housing material	AISI 316 Ti • different materials on request		
Protection [EN 60529]	IP 67		
Connection	2 m FEP-cable 4x0.25 mm ²		

Messfühler Probe	3 BU	8	SZA
	1 BN	7	
	2 WH	6	
	4 BK	5	

(probes with cable length > 2 m and different flanges are available on request)

Note: for the connection to amplifier SZA..., page 1.94

Ex - Probe • Category 1/2 - 1 • Zone 0/1 - 20

Series STSEX

Ex -Device category 1G/2G
Installation in partition wall
Zone 0 / Zone 1 (gas)

Ex -Device category 1D
Installation in Zone 20 (dust)

Terminal clamps



Design	G3/4	NPT3/4
Dimensions		
Detection range [cm/s]	water 1...100 / oil 3...200	water 1...100 / oil 3...200
Sensor length [mm]	68	68
Connection	terminal clamps	terminal clamps
ID-No.	P11268	P11269
Type	STSEX 01	STSEX 02
Ex area of use	Gas: Partition wall Zone 0 / Zone 1 / Dust: Zone 20	
Certificate No.	TÜV 98 ATEX 1298 X	
Ex marking	Gas: Ex II 1/2 G Ex ia IIC T6 Ga/Gb Dust: Ex II 1 D Ex ia IIIC T100 °C Da	
Ambient temperature and medium temperature [°C]	Gas: T6: $-20 \leq T_a \leq +40$ T5: $-20 \leq T_a \leq +55$ T4: $-20 \leq T_a \leq +60$ T3: $-20 \leq T_a \leq +60$ Dust: $-20 \leq T_a \leq +60$	
Maximum values	$U_i = 13.65 \text{ V}$ / $I_i = 200 \text{ mA}$ / $P_i = 0.69 \text{ W}$ / $C_i = 0.27 \text{ nF}$ / $L_i = 1.30 \text{ }\mu\text{H}$	
Start-up time typ. [s]	8 (2...18)	
Reaction time typ. [s]	2 (1...13)	
Terminal clamps [mm]	cable diameter 5.5...8.5	
Housing material	AISI 316 Ti • different materials on request	
Protection [EN 60529]	IP 67	
Connection cable	2 m PVC 4x0.75 mm ² (number 1-4)	

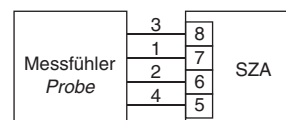
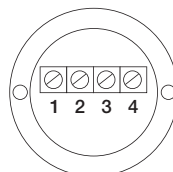

Note: for the connection to amplifier SZA..., page 1.94

Air Flow Sensors



Ex - Probe • Device category 1G/2G and 1D

Series STS

Ex - Device category 1G/2G
Installation in partition wall
Zone 0 / Zone 1 (gas)

Ex - Device category 1D
Installation in Zone 20 (dust)



Design	G1/2	
Dimensions		
Detection range [m/s]	air 2...25	air 2...25
Sensor length [mm]	65	65
Connection	fixed cable	plug
ID-No.	P11152	P11206
Type	STS 212 K	STS 212 S
Ex area of use	Gas: Partition wall Zone 0 / Zone 1 / Dust: Zone 20	
Certificate No.	TÜV 98 ATEX 1298 X	
Ex marking	Gas: Ex II 1/2 G Ex ia IIC T4 Ga/Gb Dust: Ex II 1 D Ex ia IIIC T120 °C Da	
Ambient temperature and medium temperature [°C]	Gas: T4: -20 ≤ Ta ≤ +60 T3: -20 ≤ Ta ≤ +60 Dust: -20 ≤ Ta ≤ +60	
Maximum values	Ui = 13.65 V / li = 200 mA / Pi = 0.69 W / Ci = 0.27 nF / Li = 1.30 µH	
Start-up time typ. [s]	10...40	
Reaction time typ. [s]	5 (2...30)	
Compressive strength [bar]	10	
Housing material	AISI 316 Ti • different materials on request	
Protection [EN 60529]	IP 67	IP 67
Connection	2 m PUR-cable 4x0.25 mm ²	M12 connector

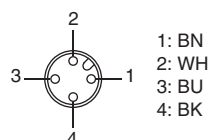

(probes with cable length > 2 m are available on request)

Note: for the connection to amplifier SZA..., page 1.94

- Probe • Device category 1G/2G and 1D

Series STS

-Device category 1G/2G
Installation in partition wall
Zone 0 / Zone 1 (gas)

-Device category 1D
Installation in Zone 20 (dust)



Design	G1/2	
Dimensions		
Detection range [m/s]	air 2...25	air 2...25
Sensor length [mm]	48	48
Connection	fixed cable	plug
ID-No.	P11153	P11207
Type	STS 215 K	STS 215 S
Ex area of use	Gas: Partition wall Zone 0 / Zone 1 / Dust: Zone 20	
Certificate No.	TÜV 98 ATEX 1298 X	
Ex marking	Gas: II 1/2 G Ex ia IIC T6 Ga/Gb Dust: II 1 D Ex ia IIIC T105 °C Da	
Ambient temperature and medium temperature [°C]	Gas: T6: $-20 \leq T_a \leq +35$ T5: $-20 \leq T_a \leq +50$ T4: $-20 \leq T_a \leq +60$ T3: $-20 \leq T_a \leq +60$ Dust: $-20 \leq T_a \leq +60$	
Maximum values	$U_i = 13.65 \text{ V}$ / $I_i = 200 \text{ mA}$ / $P_i = 0.69 \text{ W}$ / $C_i = 0.27 \text{ nF}$ / $L_i = 1.30 \mu\text{H}$	
Start-up time typ. [s]	5...20	
Reaction time typ. [s]	3 (2...30)	
Compressive strength [bar]	10	
Housing material	AISI 316 Ti • different materials on request	
Protection [EN 60529]	IP 67	IP 67
Connection	2 m PUR-cable 4x0.25 mm ²	M12 connector
Note:	(probes with cable length > 2 m are available on request) for the connection to amplifier SZA..., page 1.94	

Air Flow Sensors



Ex - Probe • Device category 1G/2G and 1D

Series STS

Ex - Device category 1G/2G
Installation in partition wall
Zone 0 / Zone 1 (gas)

Ex - Device category 1D
Installation in Zone 20 (dust)

Extended temperature range



Design	G1/2	
Dimensions		
Detection range [m/s]	air 2...25	
Sensor length [mm]	48	
Connection	fixed cable	
ID-No.	P11212	
Type	STS 215 KH	
Ex area of use	Gas: Partition wall Zone 0 / Zone 1 / Dust: Zone 20	Gas: Zone 1 / Dust: Zone 21
Certificate No.	TÜV 98 ATEX 1298 X	
Ex marking	Gas: Ex II 1/2 G Ex ia IIC T6 Ga/Gb	Dust: Ex II 1 D Ex ia IIIC T105 °C Da
Ambient temperature and medium temperature [°C]	Gas: T6: -20 ≤ Ta ≤ +35 T5: -20 ≤ Ta ≤ +50 T4: -20 ≤ Ta ≤ +60 T3: -20 ≤ Ta ≤ +60 Dust: -20 ≤ Ta ≤ +60	Gas: T6: +10 ≤ Ta ≤ +35 T5: +10 ≤ Ta ≤ +50 T4: +10 ≤ Ta ≤ +85 T3: +10 ≤ Ta ≤ +120 Dust: -20 ≤ Ta ≤ +85
Maximum values	Ui = 13.65 V / li = 200 mA / Pi = 0.69 W / Ci = 0.27 nF / Li = 1.30 µH	
Start-up time typ. [s]	5...20	
Reaction time typ. [s]	3 (2...30)	
Compressive strength [bar]	10	
Housing material	AISI 316 Ti • different materials on request	
Protection [EN 60529]	IP 67	
Connection	2 m FEP-cable 4x0.25 mm²	



(probes with cable length > 2 m are available on request)

Note: for the connection to amplifier SZA..., page 1.94

- Compact models • Device category 3D

Series LNZ 450 EX22

-Device category 3D

II 3D IP 65 T 90 °C X

DC 24 V

Relay output

Analog output

Detection range 0.5...30 m/s



Ausführung	G1/2	
Abmessungen		
Detection range [m/s]	air 0,5...30	air 0,5...30
Output	 Relay	 4...20 mA
ID-No.	P11305	P11306*
Type	LNZ 450 GR-EX22	LNZ 450 GA-EX22
Ex area of use	Dust: Zone 22	
Ex marking	II 3D IP 65 T 90 °C X	
Supply voltage [V]	24 DC ±20%	24 DC ±15%
Current consumption [mA]	80	80
Current output [mA]	4...20	-
Load R _L [Ω]	-	200...500
Switching voltage [V]	250 AC / 60 DC	-
Switching current [A]	4 AC / 4 DC	-
Switching power max.	100 VA / 60 W	-
Ambient temperature [°C]	-10 ≤ Ta ≤ +60	-10 ≤ Ta ≤ +60
Medium temperature [°C]	0...+60	0...+60
Start-up time typ. [s]	10...90	20...90
Reaction time typ. [s]	2...30	4...30
Compressive strength [bar]	30	
Material	housing: PBT sensor: 1.4305	
Display flow	LED-array	
Protection [EN 60529]	IP 65	
Connection	2 m PVC-cable 5x0.5 mm ²	2 m PVC-cable 3x0.5 mm ²
* US LISTED E304328		

- Amplifiers AC/DC

Series SZA

II (1) GD [Ex ia] IIC

AC 230 V • AC 115 V

DC 24 V

Relay output

Cable break and short circuit monitoring

Turn off delay



Design SZA 400 Ex...

Dimensions

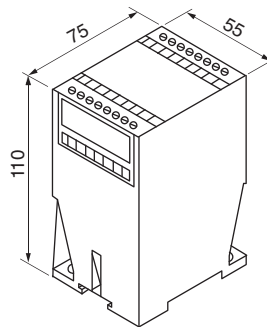

ID-No.	P10706	P10707	P10708
Type	SZA 400 Ex-230	SZA 400 Ex-115	SZA 400 Ex-24
Output	Relay	Relay	Relay
Supply voltage [V]	230 AC $\pm 10\%$	115 AC $\pm 10\%$	24 DC $\pm 15\%$
Ex marking	II (1) GD [Ex ia] IIC		
Certificate No.	TÜV 96 ATEX 1097		
Maximum values	U _o = 12.6 V I _o = 200 mA R _i = 68.5 Ω C _o = 170 nF L _o = 0.5 mH		
Turn off delay [s]	0...25		
Output	relay / change-over		
Switching voltage [V]	250 AC / 60 DC		
Switching current [A]	4 AC / 0.5 DC		
Switching power	$\cos \varphi > 0.7 / L/R < 200 \text{ ms}$		
Ambient temperature [°C]	$-20 \leq T_a \leq +60$		
Protection [EN 60529]	terminal: IP 20 / housing: IP 40		
Connection	terminal screws		

Note:

The Ex-amplifier must be mounted outside hazardous areas (gas or dust).

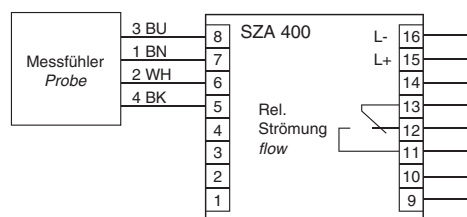



- Junction box • Device category 2G and 2D

Series GK...

For the connection of supply and signal lines in explosion hazardous areas of zone 1 and zone 21

Clamp fastening

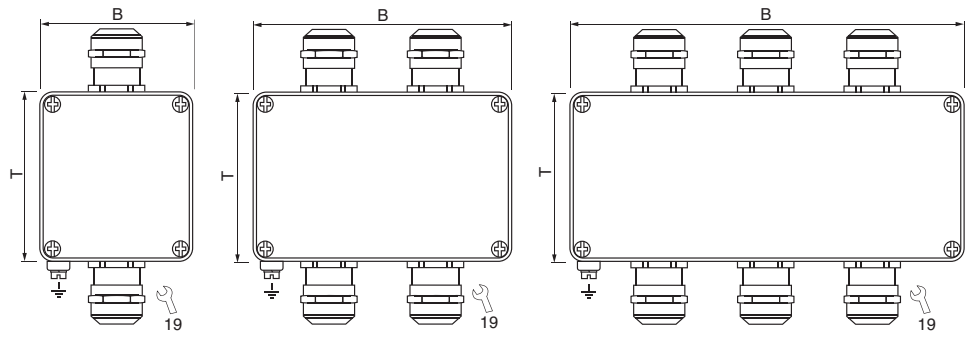

Design	GK E...		
Dimensions			
ID-No.	Z01222	Z01232	Z01246
Type	GK E 060 K M	GK E 080 K M	GK E 100 K M
Number of clamps	4	2 x 4	3 x 4
Dimensions (BxTxH) [mm]	58x64x36	98x64x36	150x64x36
Ignition protection type	Gas: increased safety		
Ex marking	Dust: protection through enclosure		
	Gas:  II 2G Ex eb IIC T6 Gb		
Certificate No.	Dust:  II 2D Ex tb IIIC T80°C Db		
	TÜV 16 ATEX 152979 X		
Ambient temperature [°C]	Gas: T3, T4, T5, T6: $-20 \leq T_a \leq +75$		
Voltage [V]	Dust: $-20 \leq T_a \leq +75$		
	$U_m \leq 275$		
Current [A]	$I_m \leq 2$		
Type of terminal	terminal with no screws		
Rated cross-section	„e+t“ single wire: 0.20...2.5 mm ² / flexible: 0.20...2.5 mm ²		
Clamping range of cable gland [mm]	flexible: 0.20...2.5 mm ² (with wire end ferrule)		
	5.0...10.0		
Material	2.0...6.0 (with reduction insert RDE 16)		
	housing: aluminium powder coated / cable gland: Br-Ni / PA / EPDM		
Protection [EN 60529]	IP 65		
Connection	terminal compartment		

Note:

The Ex-junction box type GK E... is designed for the connection of non-intrinsically safe circuits in explosion-hazardous areas of zone 1 and zone 21. Outside of the housing, the lines must be installed permanently; further provisions must be observed if required.

Additional housings, additional terminals and plastic cable glands are available on request.

Accessories	reduction insert RDE 16 (part of delivery)
-------------	--

Ex - Junction box • Device category 2G and 2D

Series GK...

For the connection of supply and signal lines in explosion hazardous areas of zone 1 and zone 21

Clamp fastening

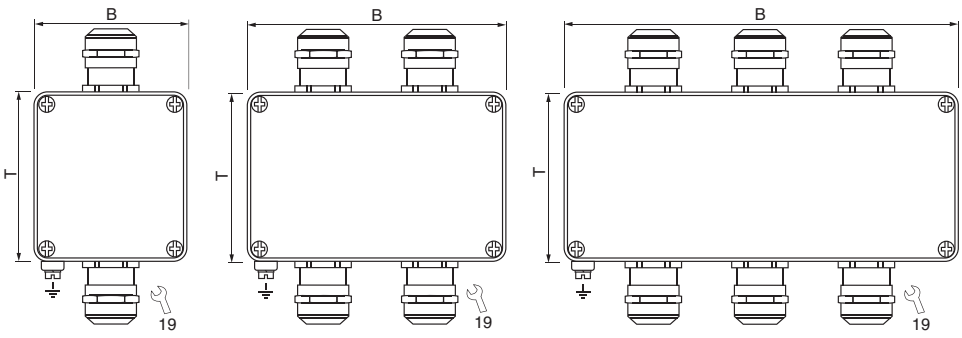

Design	GK I...		
Dimensions			
ID-No.	Z01224	Z01234	Z01248
Type	GK I 060 K M	GK I 080 K M	GK I 100 K M
Number of clamps	4	2 x 4	3 x 4
Dimensions (BxTxH) [mm]	58x64x36	98x64x36	150x64x36
Ignition protection type	Gas: intrinsic safety		
Ex marking	Dust: intrinsic safety		
	Gas: Ex II 2G Ex ib/ia IIC T6 Gb		
Certificate No.	Dust: Ex II 2D Ex ib/ia IIIC T80 °C Db		
	TÜV 16 ATEX 152979 X		
Ambient temperature [°C]	Gas: T3, T4, T5, T6: -20 ≤ Ta ≤ +75		
	Dust: -20 ≤ Ta ≤ +75		
Voltage [V]	Ui = 90		
Current [A]	Ii = 2.0		
Type of terminal	terminal with no screws		
Rated cross-section	„i“ single wire: 0.08...2.5 mm ² / flexible: 0.08...2.5 mm ² flexible: 0.08...2.5 mm ² (with wire end ferrule)		
Clamping range of cable gland [mm]	5.0...10.0		
	2.0...6.0 (with reduction insert RDE 16)		
Material	housing: aluminium powder coated / cable gland: Br-Ni / PA / EPDM		
Protection [EN 60529]	IP 65		
Connection	terminal compartment		

Note:

The Ex-junction box type GK I... is designed for the connection of intrinsically safe circuits in explosion-hazardous areas of zone 1 and zone 21. Outside of the housing, the lines must be installed permanently; further provisions must be observed if required.

Additional housings, additional terminals and plastic cable glands are available on request.

Accessories	reduction insert RDE 16 (part of delivery)
-------------	--



- Junction box • Device category 2G and 2D

Series GK...

For the connection of supply and signal lines in explosion hazardous areas of zone 1 and zone 21

Clamp fastening

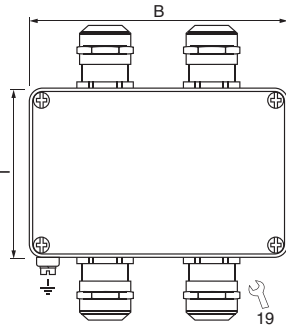
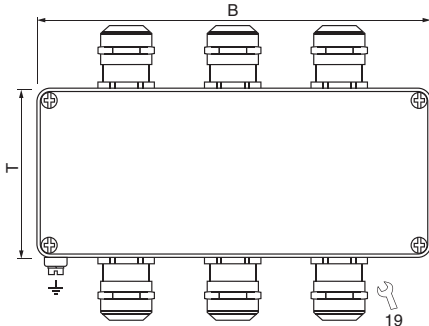

Design	GK EI...	GK EEI...	GK EII...
Dimensions			
ID-No.	Z01236	Z01250	Z01252
Type	GK EI 080 K M	GK EEI 100 K M	GK EII 100 K M
Number of clamps	4 / 4	4 + 4 / 4	4 / 4 + 4
Dimensions (BxTxH) [mm]	98x64x36	150x64x36	150x64x36
Ignition protection type	Gas: increased safety / intrinsic safety Dust: protection through enclosure / intrinsic safety		
Ex marking	Gas:  II 2G Ex eb ib/ia IIC T6 Gb Dust:  II 2D Ex tb ib/ia IIIC T80°C Db		
Certificate No.	TÜV 16 ATEX 152979 X		
Ambient temperature [°C]	Gas: T3, T4, T5, T6: $-20 \leq T_a \leq +75$ Dust: $-20 \leq T_a \leq +75$		
Voltage [V]	$U_m \leq 275 / U_i = 90$		
Current [A]	$I_m \leq 2 / I_i = 2.0$		
Type of terminal	terminal with no screws		
Rated cross-section	„i“ single wire: 0.08...2.5 mm ² / flexible: 0.08...2.5 mm ² flexible: 0.08...2.5 mm ² (with wire end ferrule) „e+t“ single wire: 0.20...2.5 mm ² / flexible: 0.20...2.5 mm ² flexible: 0.20...2.5 mm ² (with wire end ferrule)		
Clamping range of cable gland [mm]	5.0...10.0 2.0...6.0 (with reduction insert RDE 16)		
Material	housing: aluminium powder coated / cable gland: Br-Ni / PA / EPDM		
Protection [EN 60529]	IP 65		
Connection	terminal compartment		

Note:

The Ex-junction box type GK... is designed for the connection of intrinsically safe and / or non-intrinsically safe circuits in explosion-hazardous areas of zone 1 and zone 21. Outside of the housing, the lines must be installed permanently; further provisions must be observed if required.

Additional housings, additional terminals and plastic cable glands are available on request.

Zubehör	Reduziereinsatz RDE 16 (im Lieferumfang enthalten)
---------	--

Accessories • IO-Link-Master

Series IO-Link-Master

Parametrization of IO-Link-devices

Version 1.1 - Universally usable

Easy configurable software



Design	USB
Dimensions	<p>1: mini USB 2: LED operating state / fault display 3: 24 V DC Ø5.5/2.1 mm 4: M12 type A connector</p>
Application area	parametrization of devices with IO-Link-functions and monitoring of process data
Communications protocol	COM 1 (4.8 kBit/s), COM 2 (38.4 kBit/s), COM 3 (230 kBit/s)
Related software	Port and Device Configuration Tool ¹
Output	
ID-No.	Z01216
Type	IO-Link-USB-Master-Set v1.1
Input voltage [V]	USB: 5 DC / external power supply: 24 DC (EN 60950)
Input current [mA]	USB: <500 / external power supply: <600
Output voltage [V]	USB: 24 DC / external power supply: see input voltage
Output current [mA]	USB: <65 / external power supply: <500
LED displays	
Green	continuous: Master ready for operation, flashes: IO-Link-communication active
Red	continuous and green LED off: fault
Material	aluminium, eloxed
Protection [EN 60529]	IP 20
Connection	M12 connector / type A / socket
¹ Download of iqPDCT-software from www.iq2-development.de/downloads .	<p>1: +24 V 2: not used 3: GND 4: IO-Link: CH1 (C/Q) 5: not used</p> <p>1: +5 V 2: D- 3: D+ 4: not used 5: GND</p>
Accessories (incl. at delivery)	USB-connecting cable, M12-sensor-connecting cable 2 m, power supply 230 V AC / 24 V DC

Accessories • M12 connector

System SL

Finished cable plug housing
Self locking screw plug
Protection IP 67

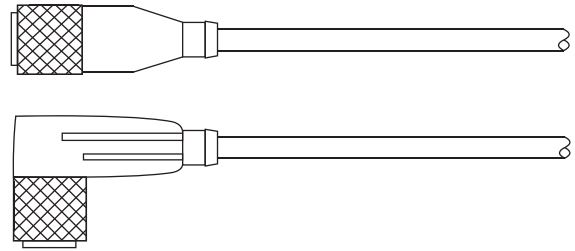

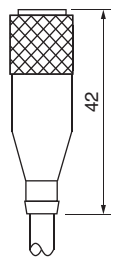
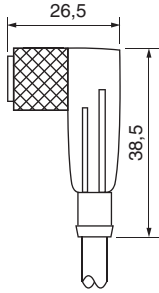
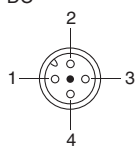
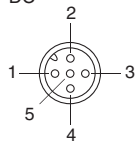
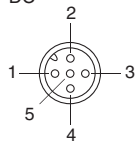
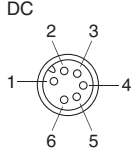
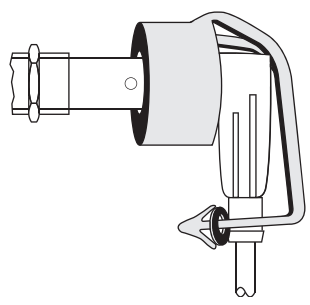
Cable plug housing	Pin-assignment	Plug-lock
<div style="display: flex; justify-content: space-around;"> <div style="text-align: center;"> <p>straight</p>  <p>42</p> <p>SLG...</p> </div> <div style="text-align: center;"> <p>angular</p>  <p>26,5</p> <p>38,5</p> <p>SLW...</p> </div> </div>	<div style="display: flex; justify-content: space-around;"> <div style="text-align: center;"> <p>DC</p>  <p>3-wire 1: BN 2: - 3: BU 4: BK</p> </div> <div style="text-align: center;"> <p>DC</p>  <p>4-wire 1: BN 2: WH 3: BU 4: BK</p> </div> <div style="text-align: center;"> <p>DC</p>  <p>5-wire 1: BN 2: WH 3: BU 4: BK 5: GY</p> </div> <div style="text-align: center;"> <p>DC</p>  <p>6-wire 1: BN 2: WH 3: BU 4: BK 5: GY 6: PK</p> </div> </div> <p style="text-align: center;">DC</p>	 <p style="text-align: center;">PL-M12</p>

TYPE	ID-NO.	DESIGN
SLG 3-2	Z01076	Cable plug housing straight, 2 m cable 3x0.34 mm ² max. 250 V / 4 A
SLG 3-5	Z01077	Cable plug housing straight, 5 m cable 3x0.34 mm ² max. 250 V / 4 A
SLW 3-2	Z01078	Cable plug housing angular, 2 m cable 3x0.34 mm ² max. 250 V / 4 A
SLW 3-5	Z01079	Cable plug housing angular, 5 m cable 3x0.34 mm ² max. 250 V / 4 A
SLW 3-2-LED	Z00052	Cable plug housing angular, 2 m cable 3x0.34 mm ² max. 250 V / 4 A PNP with LED
SLG 4-2	Z00445	Cable plug housing straight, 2 m cable 4x0.25 mm ² max. 250 V / 4 A
SLG 4-5	Z00449	Cable plug housing straight, 5 m cable 4x0.25 mm ² max. 250 V / 4 A
SLW 4-2	Z00446	Cable plug housing angular, 2 m cable 4x0.25 mm ² max. 250 V / 4 A
SLW 4-5	Z00450	Cable plug housing angular, 5 m cable 4x0.25 mm ² max. 250 V / 4 A
SLW 4-2-LED	Z01157	Cable plug housing angular, 2 m cable 4x0.25 mm ² max. 250 V / 4 A PNP with LED
SLG 5-2	Z01150	Cable plug housing straight, 2 m cable 5x0.34 mm ² max. 60 V / 2 A
SLW 5-2	Z01151	Cable plug housing angular, 2 m cable 5x0.34 mm ² max. 60 V / 2 A
SLG 6-2	Z01197	Cable plug housing straight, 2 m cable 6x0.25 mm ² max. 36 V / 2 A
SLW 6-2	Z01198	Cable plug housing angular, 2 m cable 6x0.25 mm ² max. 36 V / 2 A
PL-M12	Z01182	Plug-lock for sensors in Ex areas

DATA

Thread	M12x1	Contact resistance	≤ 5 mΩ
Material	PVC	Insulation resistance	>10 ⁹
Protection	IP 67	Testing voltage	2.0 KV eff. / 5 and 6 pol. 1.5 KV eff.
Temperature range	-25...+80 °C		

Note:

Sensors with NC output are connected to 4 pole cable plug housings. In this case, the break output is connected to the white lead (connection 2).

Accessories • M12 connector

System SB

Cable plug user-assembled
Great variety of cables
Protection IP 67



Cable plug housing straight

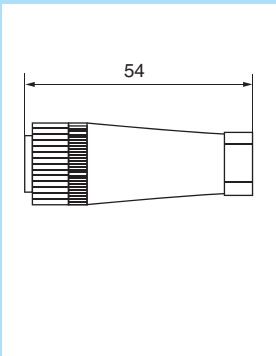

SBG...

Cable plug housing angular

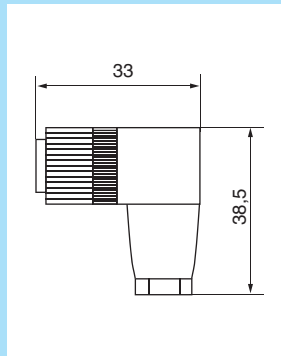

SBW...

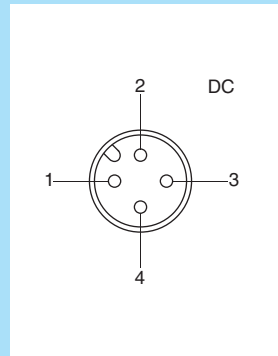

SBG.../SBW...

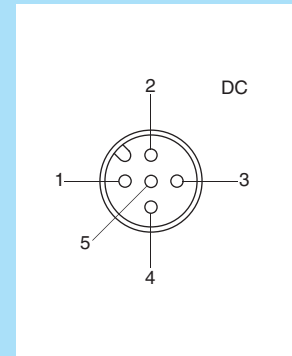

SBG 5.../SBW 5...

TYPE	ID-NO.	DESIGN
SBG-DC	Z01060	DC-Cable plug housing M12x1, straight 4-pol user assembled 30 VDC, 3 A
SBW-DC	Z00038	DC-Cable plug housing M12x1, angular 4-pol user assembled 30 VDC, 3 A
SBG 5-DC	Z01146	DC-Cable plug housing M12x1, straight 5-pol user assembled 30 VDC, 1 A
SBW 5-DC	Z01147	DC-Cable plug housing M12x1, angular 5-pol user assembled 30 VDC, 1 A

PREFERRED CABLE

PVC 205	Z01061	PVC-cable 2x0.5 mm ²	Lead colour coding: BN/BU
PVC 205B	Z01062	PVC-cable 2x0.5 mm ² , blue cable covering	Lead colour coding: BN/BU
PVC 305	Z01063	PVC-cable 3x0.5 mm ²	Lead colour coding: BN/BU/BK
PVC 434	Z01066	PVC-cable 4x0.34 mm ²	Lead colour coding: BN/BU/BK/WH
PVC 405	Z01067	PVC-cable 4x0.5 mm ²	Lead colour coding: BN/BU/BK/WH
PVC 505	Z01116	PVC-cable 5x0.5 mm ²	Lead colour coding: BN/BU/BK/WH/GY
PUR 425S	Z01069	PUR-cable 4x0.25 mm ² , shielded	Lead colour coding: BN/BU/BK/WH
PUR 425BS	Z01070	PUR-cable 4x0.25 mm ² , shielded, blue cable covering	Lead colour coding: BN/BU/BK/WH
	Z01074	Finishing of cable plug housing	
	Z01075	Finishing of cable plug housing and cable extremity	

Note

Different cables on request.

Code: BK = black BN = brown BU = blue GN = green YE = yellow GY = grey PK = pink WH = white

Accessories • cable

TYPE	ID-NO.	MATERIAL/SHEAT	Ø _A [mm]*	WIRE SPECIFICATION	COLOUR
PVC205	Z01061	PVC, grey	5.2	2x0.5 mm ²	BU, BN
PVC205B	Z01062	PVC, blue	4.4	2x0.5 mm ²	BU, BN
PVC275	Z01086	PVC, grey	6.0	2x0.75 mm ²	BU, BN
PVC275BS	Z01108	PVC, blue	6.3	2x0.75 mm ² shielded	numbered cable
PVC334	Z01109	PVC, grey	4.5	3x0.34 mm ²	BU, BN, BK
PVC305E	Z01064	PVC, grey	5.2	3x0.5 mm ²	BU, BN, GN/YE
PVC305	Z01063	PVC, grey	5.2	3x0.5 mm ²	BU, BN, BK
PVC305B	Z01167	PVC, blue	5.2	3x0.5 mm ²	BU, BN, BK
PVC375	Z01065	PVC, grey	6.0	3x0.75 mm ²	numbered cable
PVC375E	Z01111	PVC, grey	6.0	3x0.75 mm ²	BU, BN, GN/YE
PVC425	Z01110	PVC, grey	4.3	4x0.25 mm ²	BU, BN, BK, WH
PVC434	Z01066	PVC, grey	4.5	4x0.34 mm ²	BU, BN, BK, WH
PVC405	Z01067	PVC, grey	5.5	4x0.5 mm ²	BU, BN, BK, WH
PVC475E	Z01113	PVC, grey	6.5	4x0.75 mm ²	BU, BN, BK, GN/YE
PVC475BS	Z01114	PVC, blue	7.3	4x0.75 mm ² shielded	numbered cable
PVC505	Z01116	PVC, grey	5.8	5x0.5 mm ²	BU, BN, WH, BK, GY
PVC705	Z01117	PVC, grey	6.6	7x0.5 mm ²	BU, BN, WH, GN/YE, GY, PK
PUR334	Z01156	PUR, grey	5.0	3x0.34 mm ²	BU, BN, BK
PUR375	Z01068	PUR, black	6.0	3x0.75 mm ² -40°C	BU, BN, BK
PUR425S	Z01069	PUR, grey	5.0	4x0.25 mm ² shielded	BU, BN, WH, BK
PUR425BS	Z01070	PUR, blue	5.0	4x0.25 mm ² shielded	BU, BN, WH, BK
PUR405	Z01112	PUR, black	5.0	4x0.5 mm ²	BU, BN, WH, BK
PUR405BS	Z01173	PUR, blue	6.2	4x0.5 mm ² shielded	BU, BN, WH, BK
PUR475SE	Z01118	PUR, grey	9.0	4x0.75 mm ² shielded	numbered cable
PUR410E	Z01119	PUR, orange	8.0	4x1.0 mm ²	BU, BN, BK, GN/YE
FEP375S	Z01126	FEP, red	5.0	3x0.75 mm ² shielded	BU, BN, BK
FEP334	Z01071	FEP, red	3.8	3x0.34 mm ²	BU, BN, BK
FEP425S	Z01073	FEP, red	4.1	4x0.25 mm ² shielded	BU, BN, BK, WH
FEP425	Z01072	FEP, red	3.7	4x0.25 mm ²	BU, BN, BK, WH
FEP425BS	Z01125	FEP, blue	4.1	4x0.25 mm ² shielded	BU, BN, BK, WH
FEP375	Z01165	FEP, red	4.2	3x0.75 mm ²	BU, BN, GN/YE
Silikon375E	Z01121	Silicone, red	6.0	3x0.75 mm ²	BU, BN, GN/YE
Silikon475E	Z01122	Silicone, red	6.3	4x0.75 mm ²	BU, BN, BK, GN/YE
Silikon475SE	Z01115	Silicone, red	8.8	4x0.75 mm ² shielded	BU, BN, BK, GN/YE
Silikon305	Z01143	Silicone, red	5.5	3x0.5 mm ²	BU, BN, BK
PVC705SE	Z01123	PVC-transparent	9.2	7x0.5 mm ² shielded	numbered cable, GN/YE

*Tolerance of diameter ±0,4 mm

Code: BK = black BN = brown BU = blue GN = green YE = yellow GY = grey PK = pink WH = white

Accessories • Product section 1

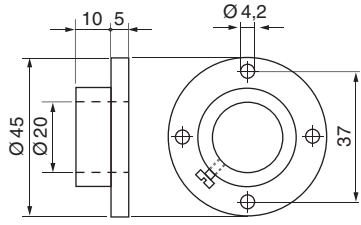
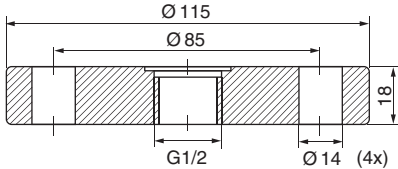
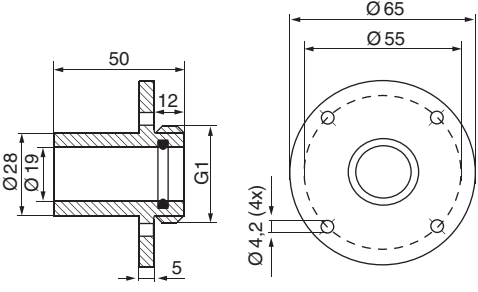
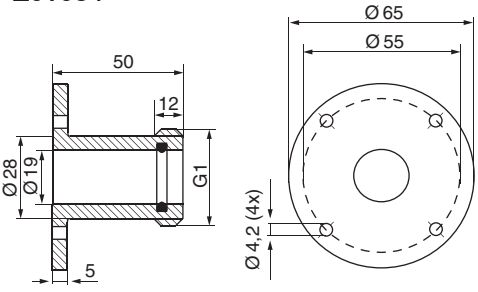
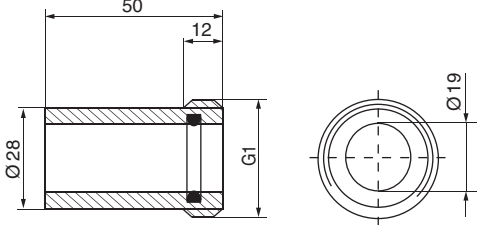
TYPE	ID-NO.	DIMENSIONS	DESIGN
Flange - Ø 20	Z01106		Plastic - flange with drilled hole Ø 20 mm for sensors type LN 520
Flange DN25/PN40	Z01001		Flange AISI 316 Ti (1.4571) EN 1092-1/05 A (DIN 2527) with central thread G1/2 for sensors type ST... with G1/2
A501	Z01033		Thread sleeve of brass, nickel-plated L=50 mm, G1 for sensors type LN...
A502	Z01034		Thread sleeve of brass, nickel-plated L=50 mm, G1 for sensors type LN...
A503	Z01035		Welding sleeve of FE 360 B (1.0037), L=50 mm, G1 for sensors type LN...

Accessories • Product section 1

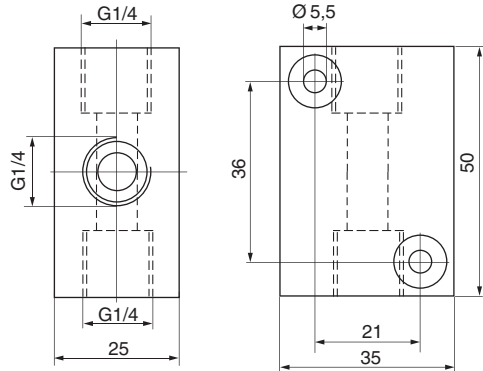
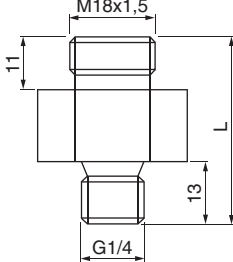
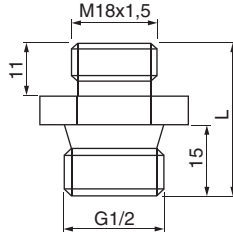
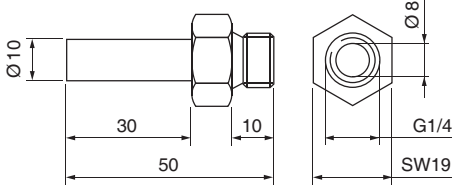
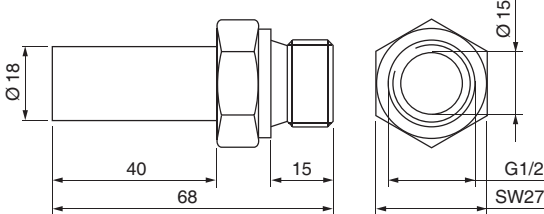
TYPE	ID-NO.	DIMENSIONS	DESIGN
SIA G1/4 - 1/4 - 1/4	Z01018		<p>Adapter for G1/4-sensors with G1/4-pipe connections</p> <p>Material: AISI 316 Ti Sensors: STK 412...</p> <p>Massflow down to 10 ml/min</p> <p>(additional models on request)</p>
SDA-SCS-G1/4	Z01200 L = 39 mm		<p>Screw-in adapter G1/4 for flow sensors SCS, SNS, SNTS and ST418</p> <p>Material: AISI 316 Ti</p>
SDA-SCS-G1/2	Z01201 L = 30 mm		<p>Screw-in adapter G1/2 for flow sensors SCS, SNS, SNTS and ST418</p> <p>Material: AISI 316 Ti</p>
SDA-SCS-G1/2-L37	Z01208 L = 37 mm		
SDA G1/4-Ø10-L050	Z01175		<p>Adapter G1/4 for flow sensors inline-digital display SDN 5.../1..., SDV 652..., SDI 852/1...</p>
SDA G1/2-Ø18-L068	Z01176		<p>Adapter G1/2 for flow sensors inline-digital display SDN 552/3...</p>



**Headquarters
EGE-Elektronik
Spezial-Sensoren GmbH**

Ravensberg 34
D-24214 Gettorf
Tel. +49 (0) 4346 / 41580
Fax +49 (0) 4346 / 5658

Internet: www.ege-elektronik.com



EGE-Elektronik ApS
Forstallé 79
DK-6200 Aabenraa
Tel. +45 70207271
Fax +45 70207272



EGE-Specialsensorer AB
Box 140
S-50113 Borås
Tel. +46 32512060
Fax +46 32512064



Stork AS
Brynsveien 100
N-1352 Kolsås
Tel. +47 67176400
Fax +47 67176401



Protocon Technologies Ltd.
Kirrintie 11 (PL 353)
40270 Palokka (40101 Jkl)
Finland
Tel. +358 (0)10 322 7100
Fax +358 (0)10 322 7119



**EGE-Elektronik
Spezial-Sensoren**
16 B rue Jean Barraud
F-77100 Nanteuil les Meaux
Tel. +33 7 81 00 50 28
Fax +49 (0) 4346 5658



Cematic-Electric B.V.
Spinel 200
NL-3316 LG Dordrecht
Telefon +31 74 2433422
Telefax +31 74 2913333



ICM Ital Control Meters Srl
Via della Valle 67
I-20048 Carate Brianza (Mi)
Tel. +39 0362 8052 00
Fax +39 0362 8052 01



Bibus Spain, S. L.
Rua do Arroncal, Vial C – Nave 4A
ES-36350 Nigran
Tel. +34 986 247286
Fax +34 986 209247



Powelectrics Limited
Unit 12 Ninian Park
Ninian Way
Tamworth
GB-Staffordshire B77 5ES
Tel. +44 1827 310666
Fax +44 1827 310999



Bachofen AG
Ackerstraße 42
CH-8610 Uster
Tel. +41 449441111
Fax +41 449441233



VWR International GmbH
Graumannsgasse 7
A-1150 Wien
Tel. +43 1 97 002 - 0
Fax +43 1 97 002 - 600



**Countpulse Controls
(PTY) LTD.**
P.O.B. 40393
ZA-2022 Cleveland
Tel. +27 116157556
Fax +27 116157513



HITECH Ltd.
1-34-12 Shimouma
Setagaya-ku
Tokyo JAPAN
Tel. +81 3-5430-2301
Fax +81 3-5430-2302



Colterlec Pty Ltd.
Unit 2 106-110 Beaconsfield Street
AUS-Silverwater NSW 2128
Tel. +61 1300 362626
Fax +61 1300 017100



**PROTEK TEKNİK ELEKTRİK
TİC. SAN. LTD. ŞTİ.**
Okçumusa Cad. Kismet Han
No: 36/2 P.K.
TR-34420 Karaköy-Istanbul
Tel. +90 212 237 20 00
Fax +90 212 235 46 09



IAC & Associates
2105 Fasan Drive
Oldcastle
CDN-Ontario NOR 1L0
Tel. +1 519 7370311
Fax +1 519 7370314
TF +1 800 711 1900



Yuden-Tech Co., Ltd.
5F., No. 121, Lide St.,
Zhonghe City, Taipei County 235,
Taiwan (R.O.C.)
Tel. +886 2 8221 2958
Fax +886 2 8221 2492



**Shanghai Beishidietian
Business Trade Co., Ltd.**
4F, No. 88-1, Lane 7039,
Zhongchun Rd., Minhang Area
Shanghai City
Tel. +86 21 54887307
Fax +86 21 54887305



Wolf Process Automation Ltd.
Unit A2.1,
Thompson Enterprise Centre
Clane Business Park,
Clane, Co. Kildare,
W91 E761, Ireland
Tel. +353 45 831575



KOLEKTOR SISTEH d.o.o.
Šlandrova ulica 10
SI-1231 Ljubljana - Črnuče
Slovenija
Tel. +386 1 5636 300
Fax +386 1 7227 930



Intról Sp. z o.o.
ul. Kościuszki 112
40-519 Katowice
Tel. +48 32 789 00 00
Fax +48 32 205 33 77



Bibus Portugal, LDA
Centro Empresarial AAA
Rua Ponte da Pedra, 240 - C4
4470-108 Gueifães - Maia
Porto
Tel. +351 22 906 50 50
Fax +351 22 906 50 53



Futron Electronics PTE Ltd.
1004 Toa Payoh North
#04-08/09/10
Singapore 318995
Tel. +65 6250 2456
Fax +65 6250 6592



Useong Electrade Co.,
D-1006, Technopark
No. 1345, Soha-dong, Gwangmyeong-si
Gyeonggi-do,
Korea
Tel. +82 (0) 2 2686 7314
Fax +82 (0) 2 2686 7316